

Linear ACCESS

AE-500

Telephone Entry & Access Control System



Installation Instructions

Linear[®]

(760) 438-7000

USA & Canada (800) 421-1587 & (800) 392-0123

Toll Free FAX (800) 468-1340

www.linearcorp.com

Contents

Introduction	2	Changing the Master Password.....	16
Operation.....	2	Resident Data Programming	17
Hardware Features	2	Entry Code Programming.....	18
Software Highlights	2	Wireless Transmitter Programming	19
Remote Keypads.....	2	System Options	20
Feature Overview.....	3	System Options (Continued)	21
Database Overview	3	System Options (Continued)	22
Component Locations	4	System Options (Continued)	23
Wiring Diagram.....	5	System Utilities.....	24
Important Mounting Requirements.....	6	System Adjustments	25
Entry System Mounting.....	7	System Diagnostics	25
Entry System Mounting (Continued)....	8	AE-500 Operation.....	26
Relay Output Wiring	9	Specifications	27
Power, Battery, & Ground Wiring.....	10	Dimension Drawing.....	27
Telephone Wiring	11	Troubleshooting	27
Optional Radio Antenna.....	11	Linear Limited Warranty.....	28
Optional Postal Lock.....	12	FCC Notice.....	28
Optional Remote Keypad.....	12		
Programming with a Computer	13		
Programming Over the Telephone	14		
Programming from the Local Keypad ..	14		
Programming Reference.....	15		
Factory Settings	15		
Programming Notes	15		
Setting Up Multiple Units	16		

Introduction

The Model AE-500 Telephone Entry & Access Control System is designed for use as a primary access control device for gated communities, parking garages, office buildings, apartments, dormitories, hotels/motels, commercial buildings and recreational facilities with up to 250 residents or users.

Housed in a locked, rugged stainless steel faced enclosure, the AE-500 features a side-lit 12-key telephone style keypad with bright, easy-to-read graphics, a backlit two-line directory display with a programmable welcome message, a built-in microphone, and speaker.

The two relay output channels can be programmed to control electric door strikes, magnetic locks, door & gate operators, or barrier gates.

The system utilizes hands-free, full duplex telephone communications between visitors and residents for granting access.

The system can be programmed locally using the keypad, remotely with a touch tone telephone, or remotely using a computer equipped with a modem and a web browser.

Before starting the installation, read and understand these instructions. Become familiar with the illustrations and wiring diagrams. They will be a guide to installing the system in an efficient and professional manner.

Operation

In a typical installation, the unit's memory would be programmed with each resident's name and directory code number. Arriving visitors would use the keypad on the AE-500 to view the directory names and directory number for the desired resident. Upon entering the directory number, the AE-500 will automatically dial the resident's telephone number and establish two-way voice communication between the visitor and the resident. The resident will then have the option to grant or deny access to the visitor by pressing a digit on their telephone.

In addition to the telephone entry, the AE-500 can grant access using entry codes (up to 500 entry codes) at the local or remote keypad. Interior and exterior remote keypads are available.

Block coded and single enrolled MegaCode® transmitters (up to a total of 1000 transmitters) can be used to gain access through the AE-500's built-in radio receiver. Each transmitter can be individually deactivated or reactivated. In addition, a single enrolled transmitter can be deleted.

Hardware Features

- ✓ **BUILT-IN RADIO RECEIVER**
Variable gain, high-sensitivity receiver for wireless access media
- ✓ **TWO FORM "C" (N.O. & N.C) RELAYS**
Each relay has 3-amp @ 30-volt rating
- ✓ **REQUEST-TO-EXIT INPUTS**
Activates the access device for exiting using a hardwired switch
- ✓ **POSTAL SWITCH OPTION**
Cabinet supports mounting a standard U.S.P.S. postal switch for mail carrier access
- ✓ **SENSING INPUT**
For sensing door position to control door-ajar and alarm features, or for access inhibit timer
- ✓ **BUILT-IN ANNUNCIATOR**
Programmable for beeps during output activations and chirps during keystrokes
- ✓ **BUILT-IN MODEM**
No add-on modem required for telephone communications with system
- ✓ **MULTIPLE UNIT SUPPORT**
Up to seven AE-500 units can be connected on the same telephone line
- ✓ **REMOTE KEYPAD SUPPORT**
The system supports one Linear remote interior or exterior keypad

Software Highlights

- ✓ **LOCALLY PROGRAMMABLE**
All programming can be performed from the local keypad
- ✓ **REMOTE TELEPHONE PROGRAMMING**
All programming can be performed with a TouchTone™ telephone over the phone line
- ✓ **REMOTE COMPUTER PROGRAMMING**
No dedicated programmer required, web-style programming with a computer and a modem
- ✓ **500 ENTRY CODES**
Up to 500 entry codes can be used for gaining access
- ✓ **2-6 DIGIT ENTRY CODE LENGTH**
Entry code lengths can be customized for small or large installations
- ✓ **250 RESIDENT DIRECTORY CAPACITY**
Up to 250 residents can have directory numbers for telephone entry
- ✓ **2-4 DIGIT DIRECTORY NUMBER LENGTH**
Directory Number lengths can be customized for small or large installations
- ✓ **500 TRANSMITTER CAPACITY**
Up to 500 block coded Linear transmitters can be used for gaining access
- ✓ **TRANSMITTER FACILITY CODE SUPPORT**
Identifies wireless access media by installation
- ✓ **TWO INDEPENDENT RELAY CHANNELS**
Each output's action is programmable
- ✓ **OBSTACLE TRANSMITTER SUPPORT**
Compatible with Linear's Model MGT transmitter

Remote Keypads

Two remote keypads are available to connect to the AE-500. One keypad can be used with each AE-500 unit. A remote keypad will activate Relay Channel "B" only. Relay Channel "A" can only be controlled by the AE-500 Keypad.

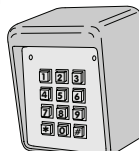

AM-KP

AM-KP Exterior Keypad

The Model AM-KP is housed in a rugged cast aluminum enclosure designed for exterior installations. The keypad can be mounted to a pedestal or directly to a wall. A keylock secures the keypad to the mounting backplate.



AM-KPI

AM-KPI Interior Keypad

The Model AM-KPI keypad is designed to be mounted indoors in a standard single-gang electrical box. Tamper resistant screws secure the keypad to its mounting plate. The die-cast keys are downlit with a white LED. The keypad is supplied with a satin-chrome bezel and three interchangeable colored bezels (white, ivory, & bronze) to customize the keypad appearance for the installation.

Feature Overview

Relay Outputs

Two 3-amp dry contact relay outputs are provided to activate access devices, such as door strikes, magnetic locks, automatic doors, barrier gates, and automatic sliding gates. One relay output can also be used as a specialty output for alarm contact shunting, operator obstacle triggering, and alarm activation. LED indicators display the status of each relay.

Request-to-Exit Inputs

Both relay channels have request-to-exit inputs. These inputs are supplied for hardwire activation of the access devices. Typically a request-to-exit input is wired to a pushbutton inside of the access controlled area. When a person desires to exit, pressing the pushbutton will activate the output relay channel and trigger the access device. A loop detector for automatic gate operation can be connected to a request-to-exit input.

Sensing Input

The sensing input connects to a door switch that monitors whether the controlled door is open or closed. The sensing input may alternately be programmed as an "access inhibit" input for use with an external access timer or service switch.

Built-in Modem

A modular connector is provided for telephone line connection to the unit's built-in 14.4K baud modem. The system can be accessed remotely for programming and control over the standard telephone system using a personal computer with a modem. For system backup, a computer connected through the modem can store and retrieve the AE-500's memory data.

Local Keypad

The local keypad is the system's primary keypad. The local keypad will activate Relay Channel "A".

Remote Keypad

Two models of remote keypads (interior and exterior) are compatible with the AE-500. A typical application for a remote keypad would be to control a second door or gate. A remote keypad will activate Relay Channel "B" only. Relay Channel "A" can only be controlled by the AE-500 keypad.

Postal Lock

The AE-500 cabinet has provisions for installing a U.S.P.S. postal lock for keyed mail carrier access. The postal lock will activate Relay Channel "A".

Obstacle Detection

Linear's Model MGT safety edge transmitter is compatible with the AE-500. The MGT detects and transmits obstacle events to the AE-500. Obstacle signals from a MGT transmitter will activate Relay Channel "B".

Programming Memory

The AE-500's EEPROM memory retains all entry codes, transmitter information, and programming, even without power.

Web-style Computer Programming

The system's built-in, web-style programming interface can be accessed using a computer with any Internet browser on-site (using a separate phone line) or off-site. The intuitive graphic display of each of the programming step is the preferred method to program the AE-500.

Local Programming

All system programming options can be set from the AE-500's keypad. A computer or dedicated programmer is not required to completely configure the AE-500.

Telephone Programming

System programming options can be set using a standard TouchTone™ telephone. By calling the AE-500 from a telephone, and entering the programming password, programming options can be changed and system functions can be controlled.

Battery Backup

The system supports a 12-volt battery backup for operation during power outage. The system does not charge the backup battery, an external battery charger is required to maintain the battery.

Database Overview

Programming the AE-500 involves entering installation information into the system's memory. The system uses this information as a reference "database" to control the operation of the system.

Resident Data

Up to 250 resident names and telephone numbers can be set. Each resident entry is assigned a directory number. Directory numbers can be from two to four digits in length (all will be the same length). The directory number is the number a visitor would enter to have the system call the resident.

RESIDENT DATA (UP TO 250 RESIDENTS)

FOR EACH RESIDENT: DIRECTORY NUMBER (2 TO 4 DIGITS)
NAME (UP TO 16 CHARACTERS)
PHONE # (UP TO 12 DIGITS)

Entry Code Data

Up to 500 entry codes can be set. Entry codes can be from two to six digits in length (all will be the same length). An entry code is a number entered at the local or remote keypad to request access. The entry code will activate Relay Channel "A" or "B" depending on which keypad the code is entered on. The AE-500 keypad controls Channel "A" Relay, the remote keypad controls Channel "B" Relay. Each entry code can be set to restrict which relay activates. Entry codes can also be set to toggle the relay output (output latches on until the next time a toggle entry code is entered). Each entry code can be set for a limited or unlimited number of uses.

ENTRY CODE DATA (UP TO 500 CODES)

FOR EACH CODE: ENTRY CODE (2 TO 6 DIGITS)
RELAY SELECTOR
TEMPORARY USAGE COUNT

Transmitter Data

Up to 1000 wireless transmitters can be used with the system. Up to 500 transmitters can be ordered in pre-programmed blocks of sequential ID codes. Up to 16 blocks of transmitters can be used. Another option is to utilize up to 500 transmitters that are singly assigned. A transmitter will activate either relay output depending on the button programming (same for all transmitters in the system). An individual transmitter can be deactivated in case it is lost or stolen. A single enrolled transmitter can also be deleted.

TRANSMITTER DATA (UP TO 1000 TRANSMITTERS)

FOR EACH TRANSMITTER: TRANSMITTER ID # (1-65535)
OPTIONAL FACILITY CODE (0-15)

Component Locations

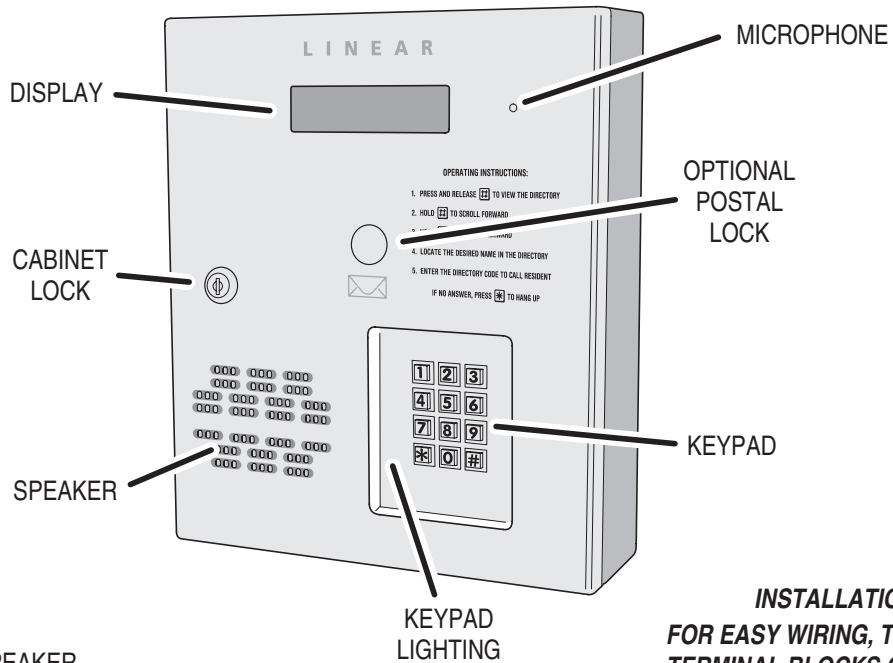

INSTALLATION NOTE:
**FOR EASY WIRING, THE UNIT'S GREEN
 TERMINAL BLOCKS CAN BE UN-PLUGGED
 FROM THE CIRCUIT BOARD**

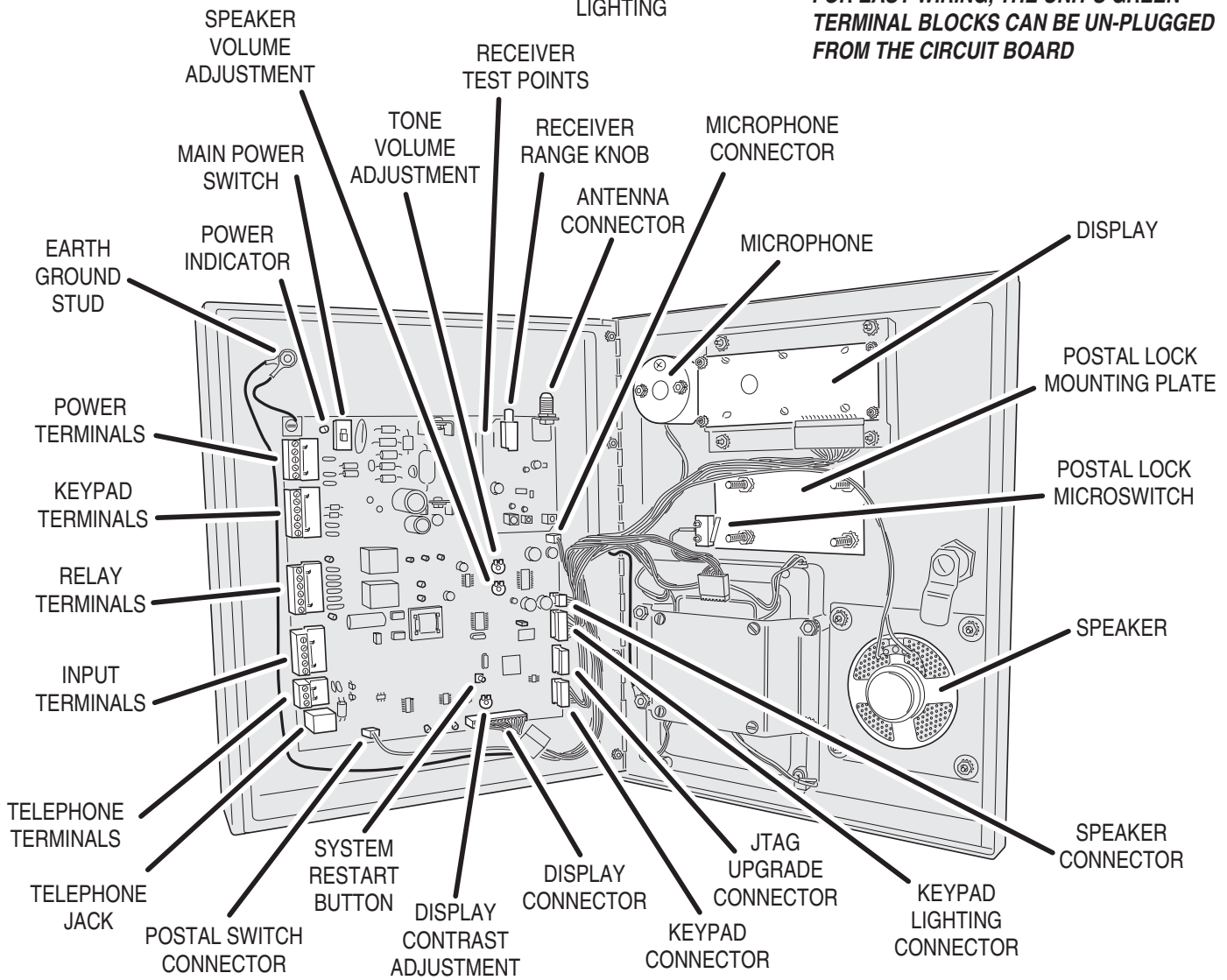

Wiring Diagram

THIS WIRING EXAMPLE SHOWS PRIMARY ACCESS WITH A DOOR STRIKE ON RELAY CHANNEL "A" AND SECONDARY ACCESS WITH A GATE OPERATOR ON RELAY CHANNEL "B"

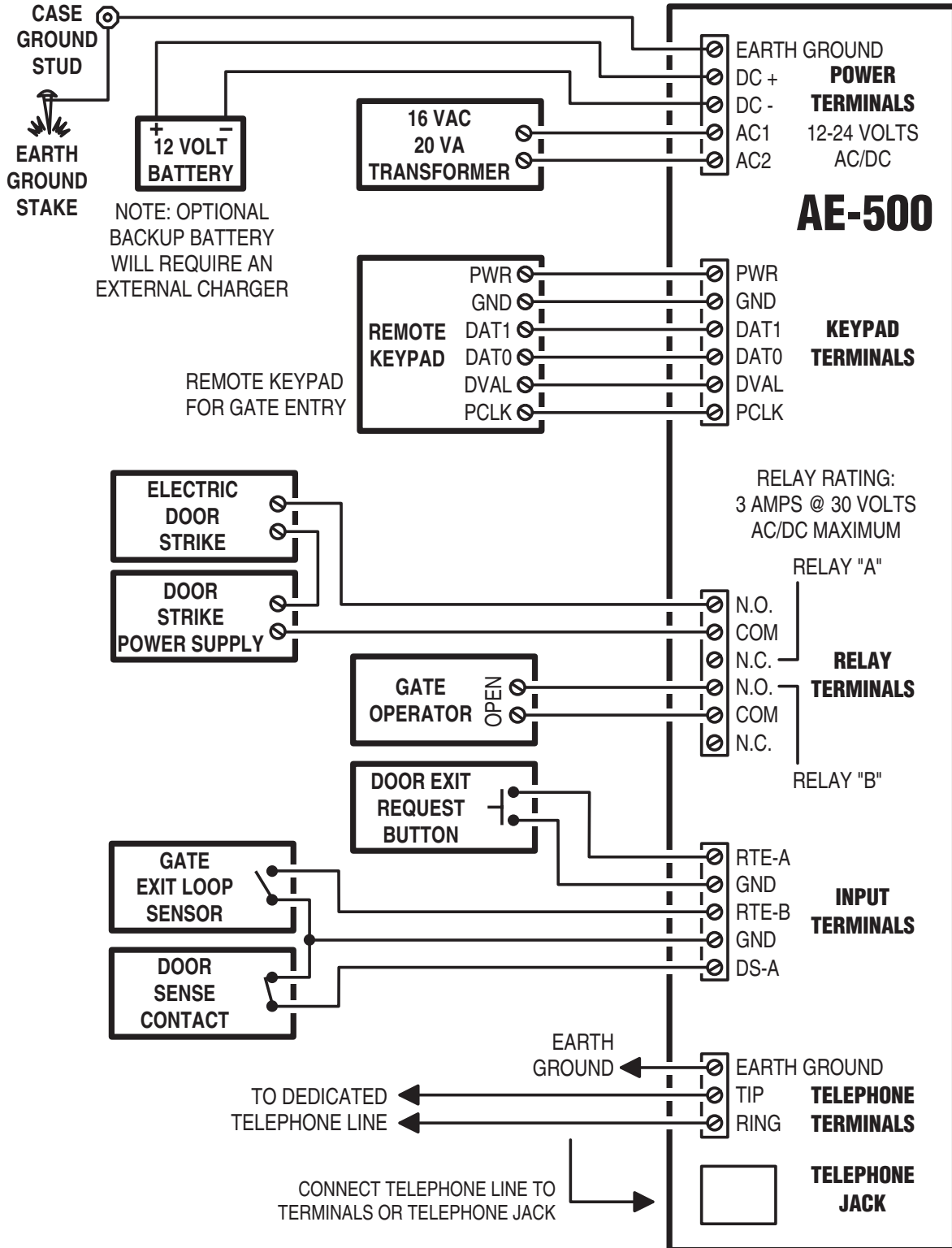

Important Mounting Requirements

The AE-500 Telephone Entry System can be installed for public or private use. The mounting requirements will vary depending on the installation. Review the following information before beginning the installation.

Mounting Environment

Consider the environmental factors at the desired mounting location. The AE-500 is designed for direct outdoor installations, however, it is preferable to protect the unit from extreme exposure to sun, driving rain, or snow whenever possible. Mounting the unit in a kiosk can provide extra environmental protection.



Follow Building Codes

Check all local building codes and ordinances prior to installing the system. Proper installation of the AE-500 conforming to the local building codes for access control equipment is a regulatory requirement. The AE-500 installation is an extremely important and integral part of the overall access control system.

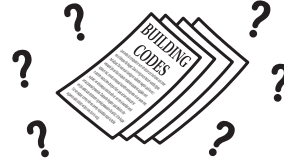

Mounting Location

If the AE-500 is used to control a door or pedestrian gate, locate the unit as near as practical to the entry point. If the unit is mounted on or in a wall adjacent to the entry point, be sure the wall is sturdy. The repeated shock and vibration from a slamming access door or spring-loaded pedestrian gate must be isolated from the AE-500. **NEVER MOUNT THE UNIT DIRECTLY TO A MOVING DOOR OR GATE!**

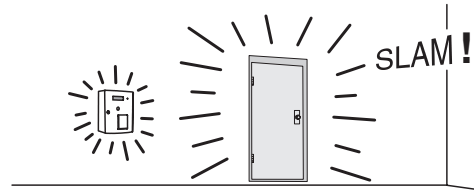

Gate Installations

If the AE-500 is used to control a gate operator connected to a vehicular gate, the unit **MUST** be mounted **AT LEAST 10 feet** away from the gate (open and closed) and gate operator. **AT NO TIME SHOULD A PERSON BE ABLE TO TOUCH THE GATE OR GATE OPERATOR AND THE AE-500 AT THE SAME TIME.**

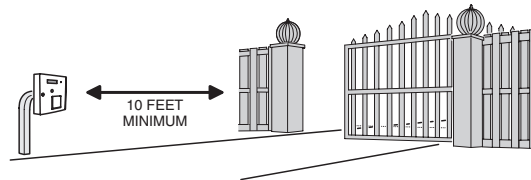

Vehicle Traffic

Do not mount the AE-500 where it extends into any traffic lane. Locate the gooseneck pedestal or entry kiosk so all parts of the AE-500 are outside the traffic lane. Locate the AE-500 clear of any turn-around lanes vehicles use when access is denied.

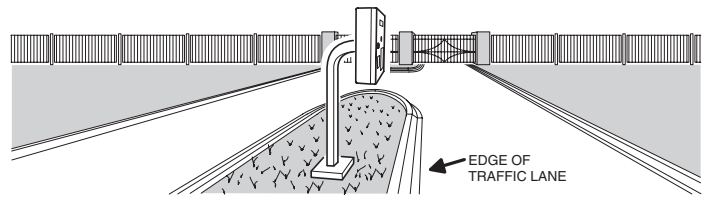

Americans with Disability Act (A.D.A.) Requirements

THE FOLLOWING WHEELCHAIR ACCESS REQUIREMENTS ARE FOR PUBLIC DOOR CONTROL INSTALLATIONS ONLY.

1. If the clear floor space allows only forward approach to the system, the maximum high forward reach allowed is 48" above grade to the top of the keypad.
2. If the high forward reach to the system is over an obstruction of greater than 20" but less than 25", the maximum high forward reach allowed is 44" above grade to the top of the keypad.
3. If the clear floor space allows parallel approach by a person in a wheelchair, the maximum high side reach shall be 54" above grade to the top of the keypad.
4. If the high side reach is over an obstruction of 24" or less, the maximum high side reach allowed is 46" above grade to the top of the keypad.



Entry System Mounting

The AE-500 cabinet is designed to be mounted three ways:

- The unit can be mounted directly to a wall or flat surface.
- The unit can be mounted recessed into a wall.
- The unit can be mounted on a standard goose-neck pedestal.

Choose a well lit location near the controlled opening. Wiring access for power, telephone, earth ground, and control output must be available to the mounting location. If the optional remote keypad or remote antenna is used, wiring access for these cables must also be available to the mounting location.

Static Electricity Warning

The unit's main circuit board contains static sensitive electronic components that can be damaged or destroyed by static discharges during installation. Discharge the static electricity from your body by touching a grounded object before handling the unit's circuit board.

Mounting Preparation

Before mounting the system, the main circuit board must be removed to provide access for the wiring hole and mounting fasteners.

◆ **CAUTION!** *Touch a grounded object before proceeding to discharge static electricity from your body.*

1. Carefully remove the six main circuit board wiring harness connectors:
 - The 2-pin postal switch connector.
 - The 16-pin display connector.
 - The 7-pin keypad connector.
 - The 8-pin keypad lighting connector.
 - The 3-pin speaker connector.
 - The 2-pin microphone connector.
2. Remove the six circuit board screws. Note how the green ground wire lugs are connected with the upper left screw.
3. Carefully remove the circuit board. Hold it by the edges. Set it aside in a safe place.

Reverse these steps to replace the circuit board after the cabinet mounting is complete and the system wiring has been routed into the panel.

Surface Mounting

The cabinet can be mounted on a wall or any suitable flat surface. The four 3/8" mounting holes or the four self-drill locations can be used to attach the cabinet to the surface.

1. For wall mounting, hold the cabinet at the approximate mounting location where the display will be about eye level or slightly above.
- 2A. If using the 3/8" mounting holes, mark the four mounting hole centers. Drill as required. Use the appropriate fasteners for the mounting surface to secure the cabinet.
- 2B. If using the self-drill mounting holes, choose the correct size bit for the fasteners and drill the cabinet as required. Use the appropriate fasteners for the mounting surface to secure the cabinet.

◆ **CAUTION!** *After drilling, remove any metal chips from the inside of the cabinet.*

3. After routing the wiring into the cabinet, replace the circuit board and plug in each wiring connector. Be sure to replace the green ground wire.

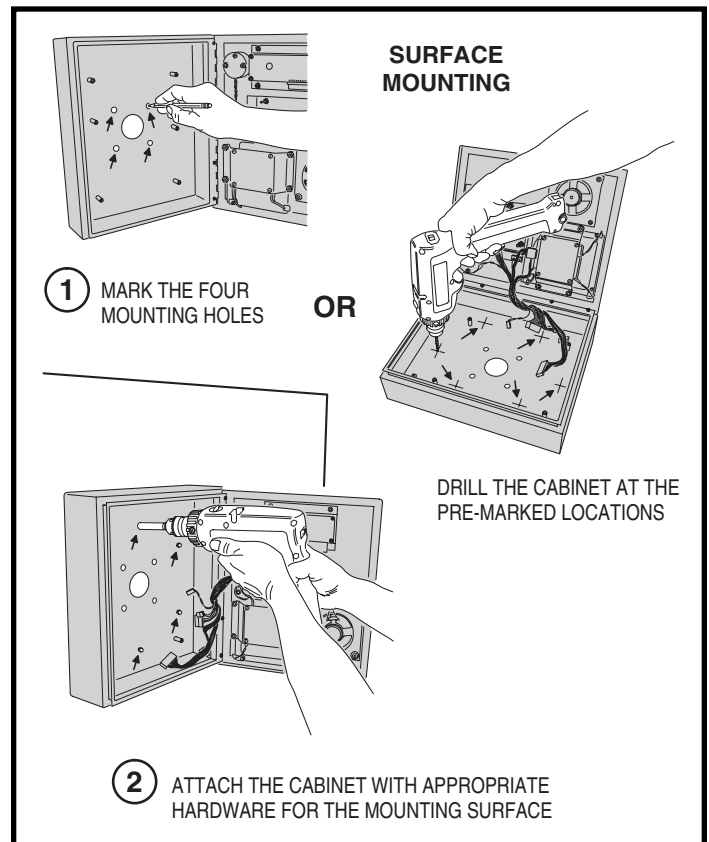
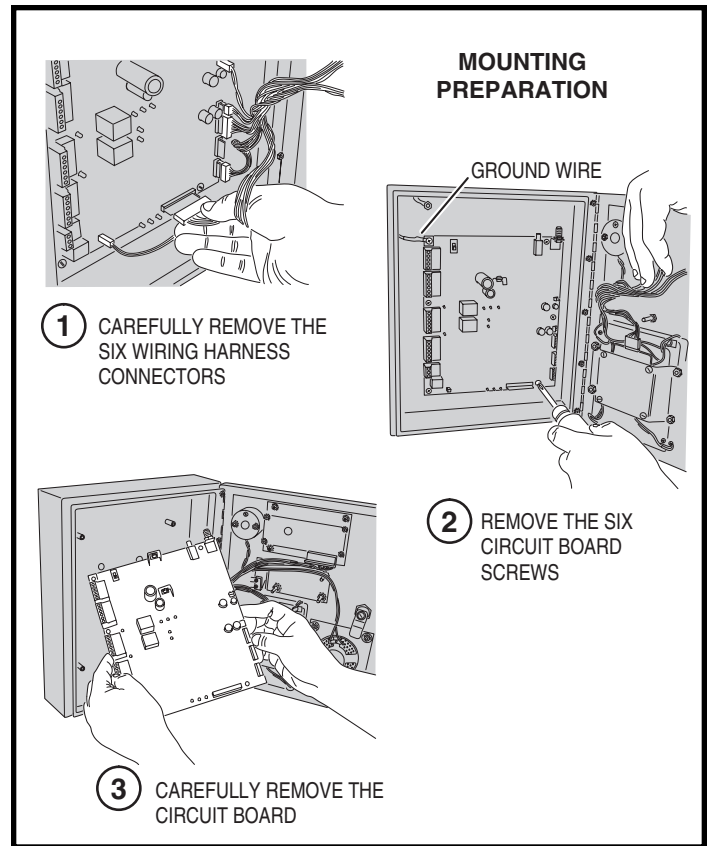

Entry System Mounting (Continued)

Recessed Mounting

The cabinet can be mounted recessed using the accessory trim-ring (P/N ACP00908). The trim-ring mounts in the wall and the cabinet attaches to the trim-ring.

1. Identify the location of any studs in the wall.
2. Cut a 13" high by 11" wide rectangular hole between studs at the mounting location.
3. Install any additional mounting material required to provide surfaces inside the wall 11" apart for attaching the trim-ring.
4. Place the trim-ring in the wall hole. Check for level, then attach the trim-ring with up to six screws into the side tabs.
5. Drill 3/16" holes in the cabinet's six pre-marked locations.

◆ **CAUTION!:** After drilling, remove any metal chips from the inside of the cabinet.

6. Route the wiring through the trim-ring and into the cabinet through the center wiring hole.
7. Attach the cabinet to the trim-ring using self-tapping screws supplied.
8. Replace the circuit board and plug in each wiring connector. Be sure to replace the green ground wires.

- 1 DETERMINE LOCATION FOR THE 11" x 13" MOUNTING HOLE

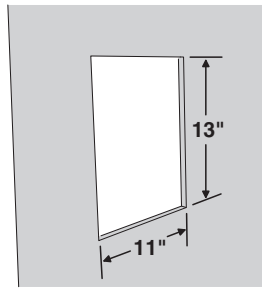

- 2 MARK HOLE LOCATION

RECESSED MOUNTING



- 3 CUT MOUNTING HOLE

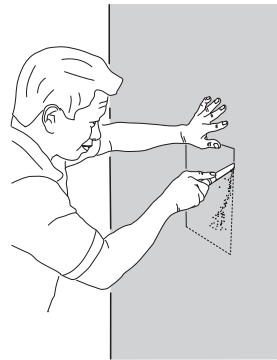

- 4 INSTALL ANY SHIMS TO ALLOW MOUNTING AND ATTACH THE TRIM-RING WITH UP TO 6 SCREWS

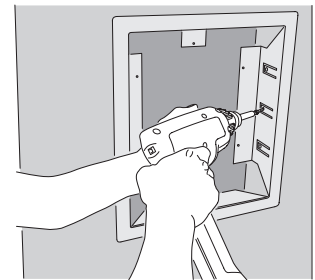

- 5 DRILL 3/16" HOLES IN THE CABINET AT THE PRE-MARKED LOCATIONS

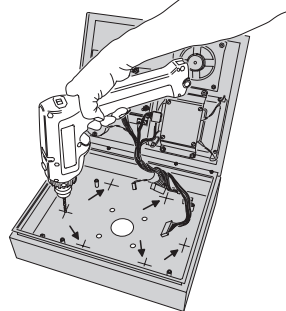

- 6 ATTACH THE CABINET TO THE TRIM-RING WITH SELF-TAPPING SCREWS

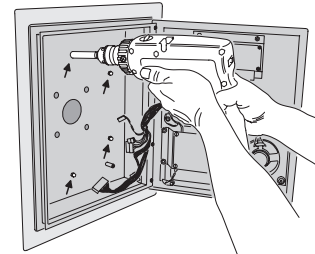

Pedestal Mounting

The cabinet can be mounted on a standard goose-neck pedestal. When mounting to a pedestal, use the cabinet reinforcing plate to stiffen the cabinet.

1. Install the pedestal at the desired location.
2. Place the reinforcing plate *inside* the cabinet.
3. Use security hardware to attach the cabinet and reinforcing plate to the pedestal.
4. After routing the wiring into the cabinet, replace the circuit board and plug in each wiring connector. Be sure to replace the green ground wires.

PEDESTAL MOUNTING

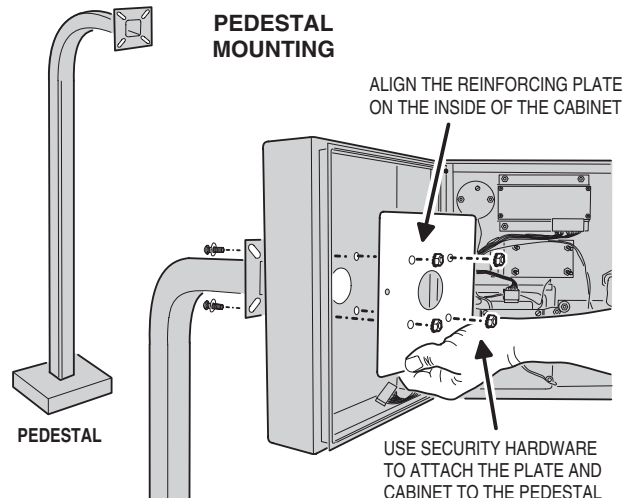

Relay Output Wiring

Either or both of the two relay output channels (A or B) can be used to control door or gate access. Relay Channel "B" can be used for alarm control functions.

Door or Pedestrian Gate Control

1. Install a low voltage electric door strike or magnetic lock as a locking device for the door or pedestrian gate.
2. Install the power supply or transformer for the locking device. **DO NOT POWER THE AE-500 FROM THIS POWER SUPPLY.**
3. Connect one wire from the power supply to one wire from the locking device.
4. Route two wires between the locking device and the AE-500. Connect one wire to the remaining wire of the locking device. Connect the other wire to the remaining wire of the power supply.
- 5A. For a door strike, connect the wires to the AE-500 relay **COM** & **N.O.** terminals.
- 5B. For a magnetic lock, connect the wires to the AE-500 relay **COM** & **N.C.** terminals.

Gate Control

1. Route two wires between the gate and the AE-500.
 2. Connect the gate operator's **OPEN** terminals to the AE-500 relay **COM** & **N.O.** terminals.
- ◆ **NOTE:** For operator wiring specifics, refer to the gate operator's wiring diagram.

Request-to-Exit Inputs

Each relay output has a request-to-exit input terminal. Grounding this terminal will activate the associated relay. These inputs are typically used with push bars, loop sensors, or pushbuttons.

1. Install the pushbutton or device to signal an exit request.
2. Route two wires from the device to the AE-500.
3. Connect the device's normally open output to the wires.
- 4A. To activate Relay Channel "A", connect the wires to the **RTE-A** and **GND** terminals.
- 4B. To activate Relay Channel "B", connect the wires to the **RTE-B** and **GND** terminals.

Sensing Input

The sensing input connects to a door switch that monitors whether the controlled door is open or closed. The sensing input may alternately be programmed as an "access inhibit" input for use with an external access timer or service switch to prevent access from being granted with Relay Channel "A".

- 1A. To use the door sense feature to detect forced entry or door ajar conditions, install a normally closed door switch on the door or pedestrian gate and route two wires from the switch to the AE-500.
 - 1B. To use the sensing input as an access inhibit input, install an external timer or service switch with a normally open output and route two wires from it to the AE-500.
 2. Connect the sensing device wires to the **DS-A** and **GND** terminals.
- ◆ **NOTE:** To program the sensing input as access inhibit, refer to the Sensing Input Function (PPN #54) step in the System Options section of these instructions.

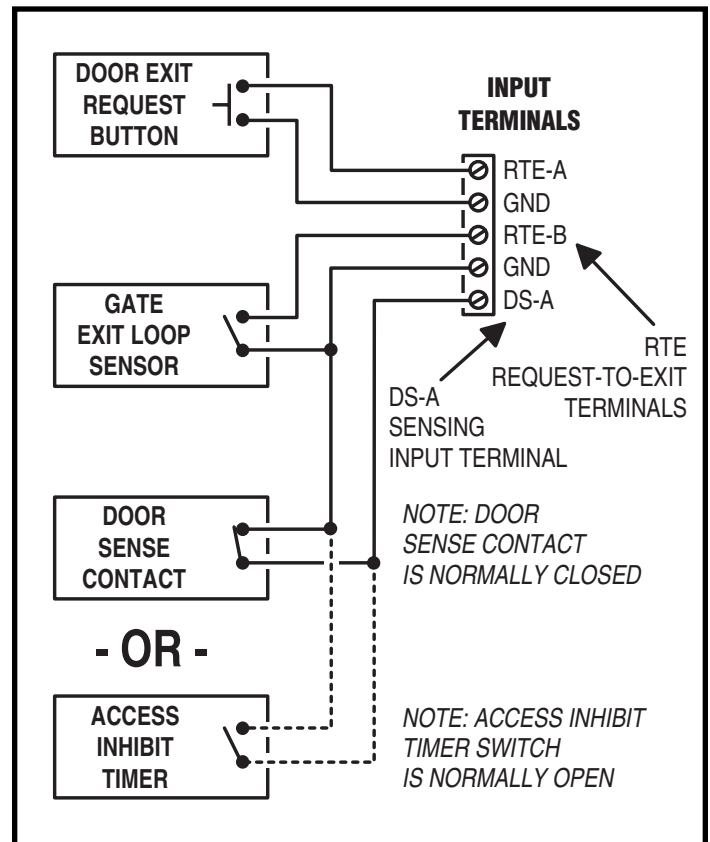
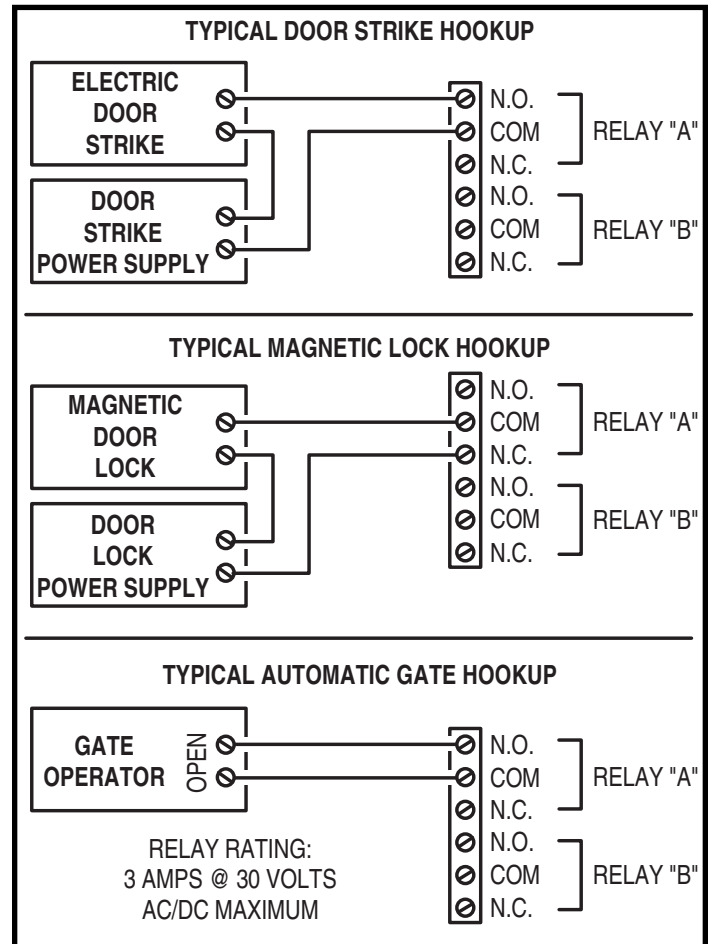

Power, Battery, & Ground Wiring

Power Wiring

◆ **NOTE: DO NOT APPLY POWER UNTIL THE INSTALLATION IS COMPLETE. TURN MASTER POWER SWITCH OFF BEFORE WIRING.**

1. Route two wires between the AE-500 and the power transformer.
 - For power wire runs up to 100 feet, use 18 AWG, THHN 600-volt insulated wire.
 - For power wire runs up to 200 feet, use 16 AWG, THHN 600-volt insulated wire.
2. Connect the wires to the transformer. Connect the other end of the wires to the AE-500 **AC1** & **AC2** terminals.

Backup Battery

Use of battery backup is optional. It will allow the AE-500 to operate for short periods of time without AC power. The door or gate access device must use some type of battery backup of its own for the entire system to be functional.

◆ **NOTE: The AE-500 does not supply battery charging current. An external battery charger will be required to maintain the battery.**

A backup battery will not fit into the AE-500 case. Protect the backup battery inside a rain-tight NEMA enclosure suitable for the installation.

◆ **NOTE: A backup battery is not required to maintain the AE-500 programming memory during power outages.**

1. Route two wires between the AE-500 and the backup battery.
2. Connect the battery positive to the **DC+** terminal.
3. Connect the battery negative to the **DC-** terminal.

Earth Ground

For the best ground, use size 12 gauge solid wire or larger to connect the AE-500 to an 8-foot copper ground rod. Locate the ground rod next to the Power and Telephone company rods and bond the rods together with a new clamp. Do not disturb the clamps installed by the Power or Telephone Company. Alternately, connect to a cold water pipe for the earth ground.

1. Connect the wire from the earth ground to the AE-500's **CASE GROUND STUD**.

◆ **NOTE: The EARTH GROUND terminal is internally connected to the circuit board ground, which is connected by a green ground wire to the EARTH GROUND STUD.**

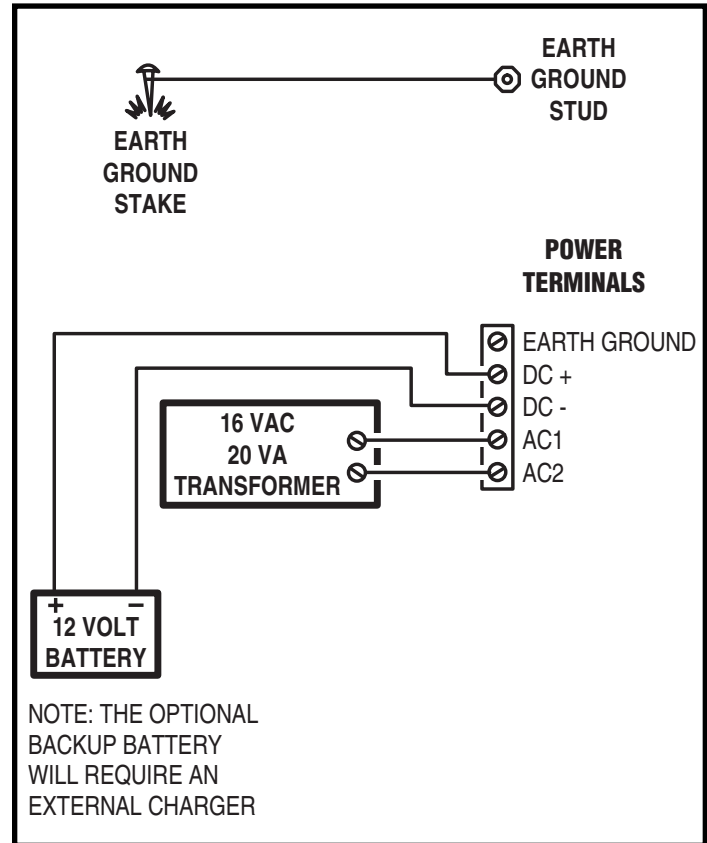

Telephone Wiring

For telephone entry and programming, the AE-500 connects to a standard telephone line.

Important Telephone Wiring Tips

- DO NOT ROUTE TELEPHONE AND AC WIRING INSIDE THE SAME CONDUIT. Route all telephone wires inside a dedicated conduit that is at least six inches away from any AC line wiring.
- All telephone wiring must be made on the “building” side of the telephone company’s demarcation device (the terminal block where the telephone line connects to the building).
- If any security system or personal alert system at the installation is connected to the telephone line, be sure that it is connected to the line ahead of the AE-500 using a RJ-31X or RJ-38X interface.
- Use only high-quality telephone wire. All telephone wire should be twisted-pair with a minimum size of 24 AWG.

Typical Telephone Wiring

- 1A. If using the AE-500 modular connector for the telephone connection, connect a double-ended modular cable between the AE-500’s **TELEPHONE JACK** and the modular telephone jack wired to the installation’s telephone line.
- 1B. If using the AE-500 terminal block for the telephone connection, check the polarity of the wires with a DC voltmeter before connecting the telephone line. Connect the negative wire (usually green) to the **RING** terminal. Connect the positive wire (usually red) to the **TIP** terminal.
2. Connect the AE-500’s telephone terminal labeled **EARTH GROUND** to telephone line ground (optional).

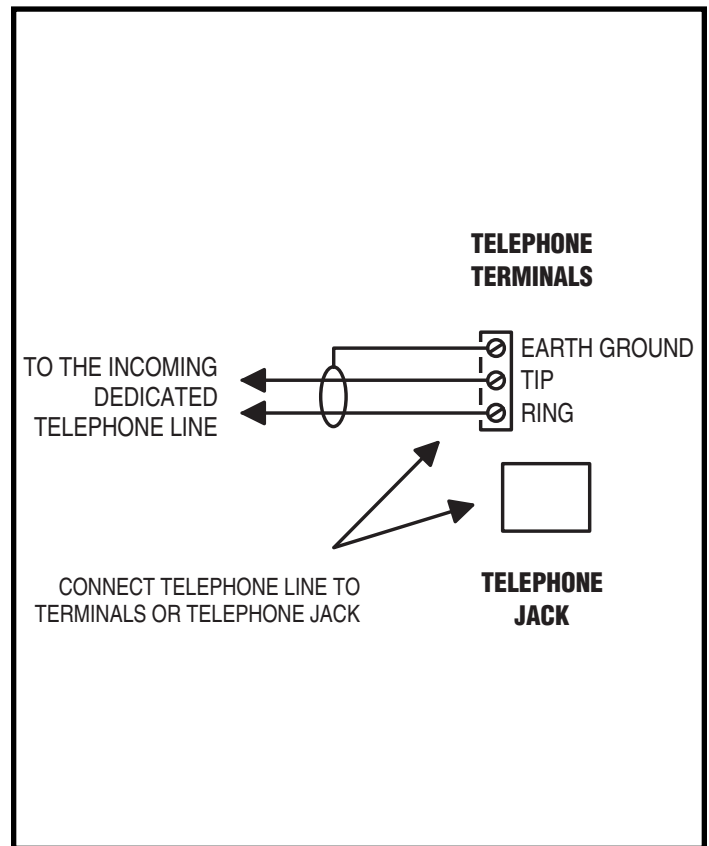

Optional Radio Antenna

If wireless transmitters are going to be used in the system a remote antenna must be installed to provide reception for the AE-500.

A basic antenna kit is supplied with the AE-500. The kit contains a whip antenna, connector, and a 36" length of coax cable. The antenna connector should be mounted on a metal surface using a 3/8" hole.

Two other models of antennas are compatible with the AE-500. The Model EXA-1000 is a omni-directional antenna. The Model EXA-2000 is a directional antenna used in installations where transmitted signals are required to be received only in a particular direction.

◆ **NOTE:** Up to 50 feet of type RG-59 coax can be used to connect the antenna to the AE-500. Keep the coax as short as possible.

1. Install the antenna. (See installation instructions if using the EXA-1000 or EXA-2000.)
2. Connect the antenna coax cable to the antenna and route the cable to the AE-500.
3. Connect the cable to the AE-500’s **ANTENNA** connector.

Receiver Range Control

The AE-500 has a **RECEIVER RANGE** adjustment knob. In some installations, it may be necessary to reduce the effective radio range of the receiver to limit the distance that transmitters can be used. Reducing the radio’s sensitivity may also help in installations where unwanted interference is overpowering signals from transmitters.

1. After the installation and system programming is complete, adjust the **RECEIVER RANGE** knob to suit the installation. Test transmitters from typical locations that they will be used. Set the receiver range so the system can activate from transmitters from about 25% more distance than required.

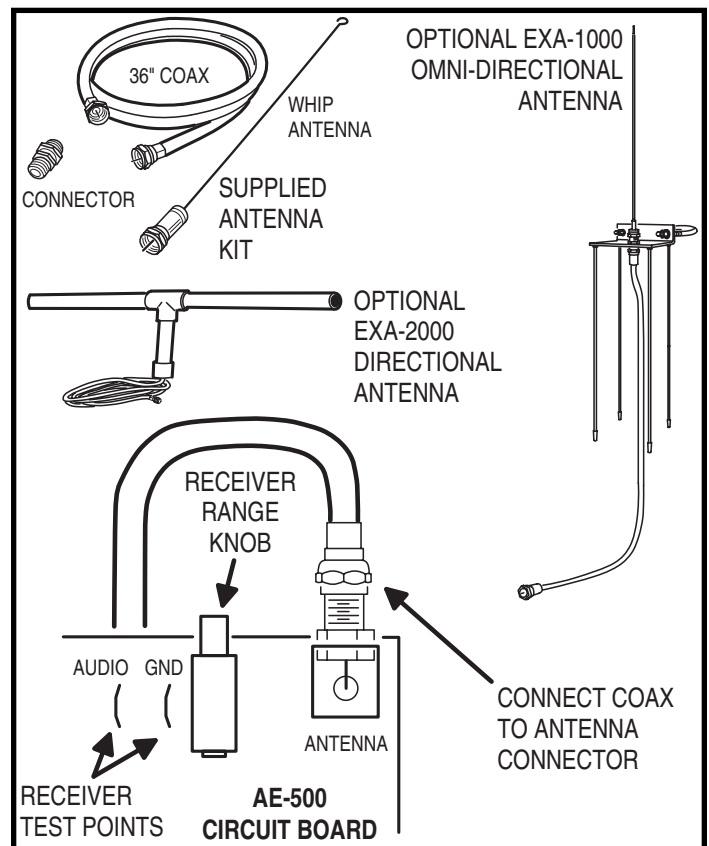

Optional Postal Lock

A postal lock can be installed in the AE-500 Entry System to provide keyed access for the postal service. The AE-500 case is designed to accept a U.S. Postal Service postal lock. When the postal lock is engaged, Relay Channel "A" will activate.

Postal Lock Installation

1. Remove the four locknuts that retain the postal lock switch plate (above the keypad on the AE-500 faceplate).
 2. Remove the switch plate from the four studs.
 3. Install the postal lock assembly onto the four studs. The postal lock's moving plunger should point towards the cabinet hinge (see figure).
 4. Replace the postal lock switch plate with the microswitch oriented inward where it will be pressed by the postal lock's moving plunger (see figure).
 5. Secure the postal lock and switch plate with the four locknuts.
- ◆ **NOTE:** Be sure the postal lock's plunger actuates the microswitch. Adjust the switch plate and the postal lock then test the action until the microswitch fully actuates.
6. Tighten the four locknuts after the adjustment and testing is complete.

1 REMOVE LOCKNUTS

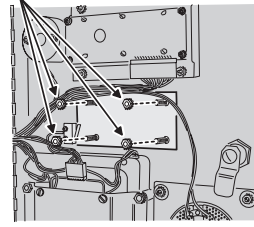

2 REMOVE PLATE

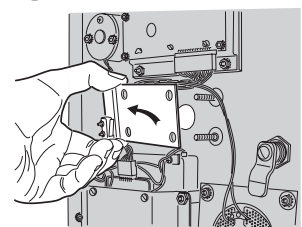

3 INSTALL POSTAL LOCK

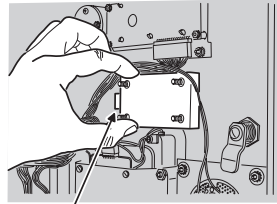

PLUNGER POINTS TO CABINET HINGE

4 REPLACE PLATE WITH THE MICROSWITCH TOWARDS THE FRONT OF THE CABINET, REPLACE LOCKNUTS

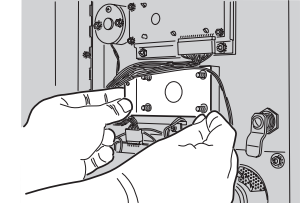

NOTE: BE SURE THE POSTAL LOCK'S PLUNGER ACTUATES THE MICROSWITCH. ADJUST THE SWITCH PLATE AND THE POSTAL LOCK THEN TEST THE ACTION UNTIL THE MICROSWITCH FULLY ACTUATES

Optional Remote Keypad

A remote keypad can be connected to the AE-500. A typical application for a remote keypad would be to control a second door or gate. A remote keypad will activate Relay Channel "B" only. Relay Channel "A" can only be controlled by the AE-500 keypad.

Two models of keypads are available to connect to the AE-500. One keypad can be used at a time with each AE-500 unit.

AM-KP Exterior Keypad

The Model AM-KP is housed in a rugged cast aluminum enclosure designed for exterior installations. The keypad can be mounted to a pedestal or directly to a wall. A keylock secures the keypad to the mounting backplate.



AM-KP

AM-KPI Interior Keypad

The Model AM-KPI keypad is designed to be mounted indoors in a standard single-gang electrical box. Tamper resistant screws secure the keypad to its mounting plate. The die-cast keys are illuminated with white LEDs. The keypad is supplied with a satin-chrome bezel and three interchangeable colored bezels (white, ivory, & bronze) to customize the keypad appearance for the installation.



AM-KPI

1. Mount and install the keypad as described in its installation instructions.
2. Route 6-conductor cable from the AE-500 to the keypad.
 - For wire runs up to 300 feet use 24 AWG Belden Type 9931 or equivalent.
 - For wire runs up to 600 feet use 20 AWG Weico Type 9405 or equivalent.
3. Set the **DEVICE ADDRESS** rotary switch in the keypad to address number one.
4. Connect the 6-conductor cable to the keypad and the AE-500 **KEYPAD** terminals as shown in the figure.

KEYPAD TERMINALS

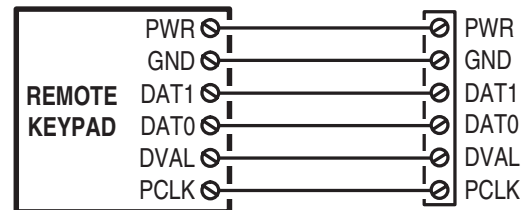

SET THE REMOTE DEVICE ADDRESS TO 1

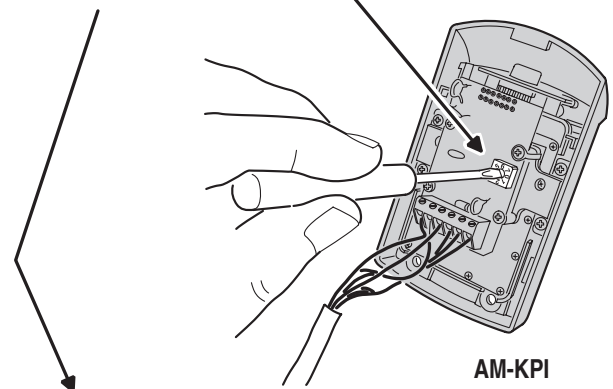

AM-KPI REMOTE KEYPAD

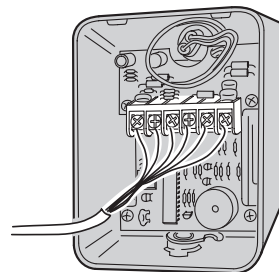

AM-KP REMOTE KEYPAD

Programming with a Computer

The AE-500's built-in programming interface can be accessed on-site (using a separate telephone line) or off-site using a computer with a modem and Internet Explorer browser (with Sun Java installed). The AE-500 can be programmed using the local keypad or with a telephone, but computer programming is the easiest method.

Navigating through the AE-500's programming n "pages" is similar to browsing through your favorite web site's pages. Anyone familiar with

the Internet will find programming the AE-500 with a computer very easy. The AE-500's memory contains the "pages" that the computer will view. When selections and changes are made on the computer, the AE-500's memory is programmed to your custom settings.

The following screen pictures show setting up a "Dial-up" connection in Windows™ XP and how to connect with a single AE-500. To create "Dial-up" connections for multi-unit installations, see Page 16.

1. FROM CONTROL PANEL SELECT "NETWORK CONNECTIONS" THEN SELECT "NEW CONNECTION WIZARD"

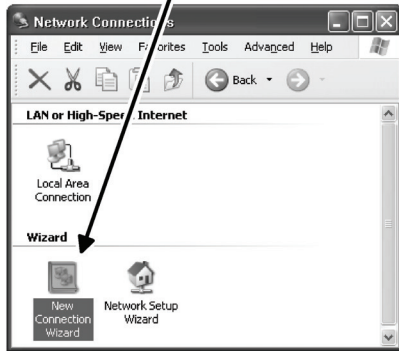

4. NEW CONNECTION WIZARD - "GETTING READY" SELECT "SET UP MY CONNECTION MANUALLY"

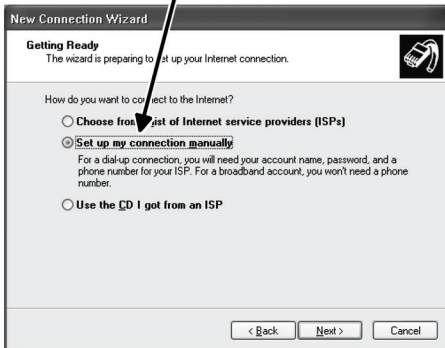

2. THE NEW CONNECTION WIZARD WILL START CLICK "NEXT"

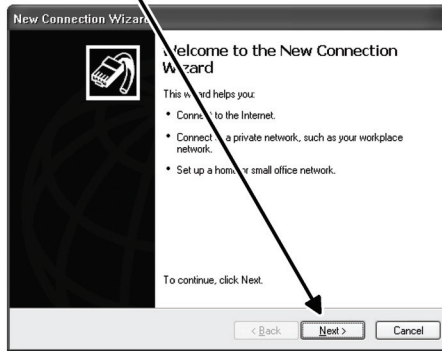

5. NEW CONNECTION WIZARD - "INTERNET CONNECTION" SELECT "CONNECT USING DIAL UP MODEM"

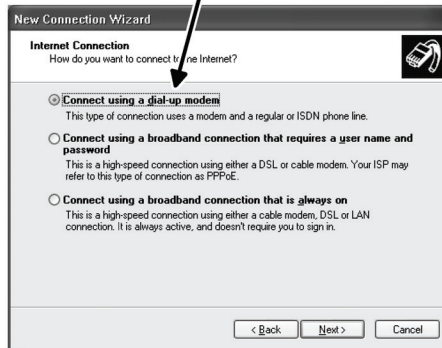

3. NEW CONNECTION WIZARD - "NETWORK CONNECTION TYPE" SELECT "CONNECT TO THE INTERNET" OPTION

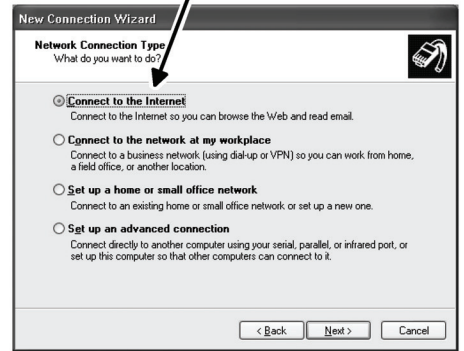

6. NEW CONNECTION WIZARD - "CONNECTION NAME" ENTER "AE-500" AS THE "ISP NAME"

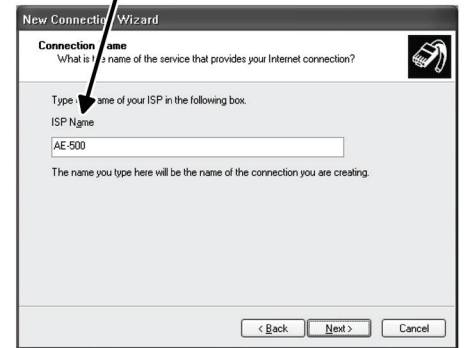

7. NEW CONNECTION WIZARD - "PHONE NUMBER TO DIAL" ENTER THE TELEPHONE NUMBER OF THE AE-500'S LINE

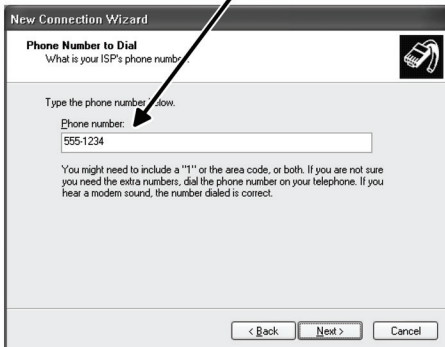

8. NEW CONNECTION WIZARD - "INTERNET ACCOUNT INFORMATION" ENTER "Linear" AS USER NAME AND "123456" AS PASSWORD

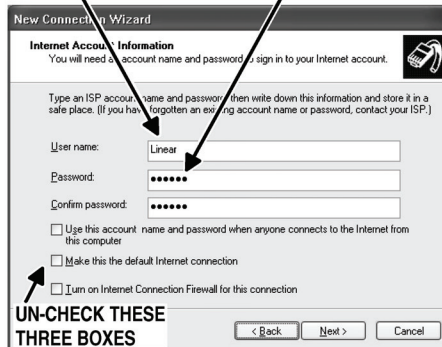

9. NEW CONNECTION WIZARD - "COMPLETING THE WIZARD" SELECT "ADD SHORTCUT" AND CLICK "FINISH"



10. DOUBLE-CLICK ON DESKTOP ICON TO LAUNCH CONNECTION WINDOW



AE-500

11. CLICK "DIAL" TO START CONNECTION

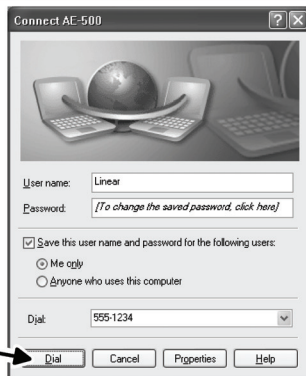

12. THE MODEM WILL DIAL THE NUMBER

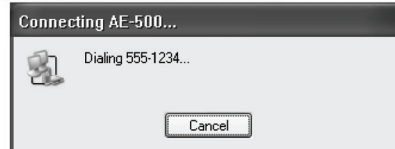

13. THE AE-500 CHECKS THE USER NAME AND PASSWORD



14. AFTER CONNECTING, SWITCH TO YOUR BROWSER SOFTWARE (MICROSOFT INTERNET EXPLORER, NETSCAPE NAVIGATOR, ETC.) AND ENTER THIS ADDRESS: <http://192.6.94.2/ae500.html>

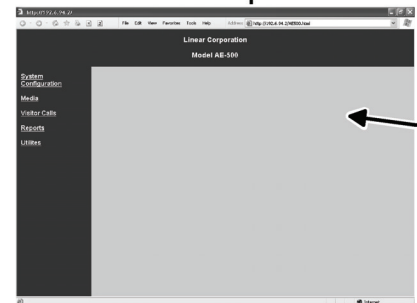

15. THE AE-500 "HOME PAGE" WILL DISPLAY ON YOUR BROWSER

Programming Over the Telephone

The system can be programmed using a TouchTone™ telephone. The telephone's keypad will act similar to the AE-500's local keypad.

Connecting with a Telephone

1. Place a call to the telephone number of the line that AE-500 is connected to.
2. The AE-500 will answer and sound a tone for about ½ second.
3. After the tone, enter the master password, then press # (factory setting is 123456). If the password is correct, the system will sound two short beeps. **For multi-unit installations, enter the unit number then # before entering the password.**
4. Programming commands can now be entered from the telephone's keypad. Refer to the following sections of this manual for programming step details.

When programming over the telephone, each programming step consists of entering programming data using the keypad. The system will sound beeps over the telephone to indicate correct or incorrect entries.

- After a correct entry, two short beeps will sound.
- After an incorrect entry, a long beep will sound.
- After the complete programming step has been entered correctly, three short beeps will sound.

Re-entering a Command After a Mistake

If an incorrect entry, or an incorrect key is pressed during programming, press ***** and start the programming step over again.

Exiting Programming Mode

1. Press: **9 9 #**
- ◆ **NOTE:** The AE-500 will automatically exit Programming Mode after five minutes of programming inactivity.

1. CALL THE SYSTEM
2. WAIT FOR THE TONE TO FINISH
3. ENTER THE MASTER PASSWORD THEN PRESS # (TWO BEEPS SOUND WITH THE CORRECT PASSWORD)

NOTE: FOR MULTI-UNIT INSTALLATIONS, ENTER THE UNIT NUMBER THEN # BEFORE ENTERING THE PASSWORD THEN #

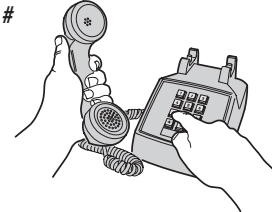

WHEN ENTERING COMMANDS:

CORRECT ENTRY = TWO SHORT BEEPS

INCORRECT ENTRY = ONE LONG BEEP

AFTER A COMPLETE STEP = THREE SHORT BEEPS

Programming from the Local Keypad

The system can be programmed using the local keypad on the faceplate of the AE-500. The display will show the programming information.

- ◆ **NOTE:** When entering text, programming the AE-500 from a computer is the preferred method.

Accessing Programming from the Local Keypad

1. Press **0** & **2** keys at the same time, then release.
2. The display will show [PASSWORD:].
3. Enter the master password (factory setting is 123456).
4. Press: **#**
5. If the password is correct, the display will show [ENTER FUNCTION:].
6. Programming commands can now be entered on the local keypad. Refer to the following sections of this manual for programming step details.

Re-entering a Command After a Mistake

If an incorrect entry, or an incorrect key is pressed during programming, to clear the keypad press ***** and start the programming step over again.

Exiting Programming Mode

1. Press: **9 9 #**
- ◆ **NOTE:** The AE-500 will automatically exit Programming Mode after five minutes of programming inactivity.

LOCAL KEYPAD ALPHANUMERIC ENTRY (FOR PROGRAMMING STEPS REQUIRING TEXT)

NOTE: FOR EASY TEXT ENTRY PROGRAM THE SYSTEM USING A COMPUTER

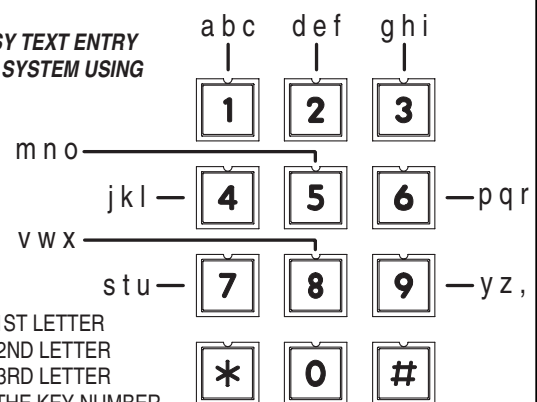

- 1ST PRESS IS 1ST LETTER
- 2ND PRESS IS 2ND LETTER
- 3RD PRESS IS 3RD LETTER
- 4TH PRESS IS THE KEY NUMBER
- 5TH PRESS IS 1ST LETTER AGAIN

space, minus sign, dot

- WAIT 3 SECONDS FOR THE NEXT CHARACTER (A BEEP WILL SOUND AFTER THE 3 SECOND DELAY TIME) OR PRESS ANOTHER KEY
- THE FIRST LETTER OF EACH WORD WILL BE UPPER CASE, TO MAKE AN ENTIRE WORD UPPER CASE TEXT, ENTER # FIRST
- FINISH ENTRY BY ENTERING #
- PRESS STAR KEY TO BACKSPACE, PRESS STAR AGAIN TO ERASE LINE

Programming Reference

PROGRAMMING CONTROL

USAGE	KEYSTROKES
ENTER PROGRAMMING FROM LOCAL KEYPAD	Press 0 and 2 then MASTER PASSWORD
ENTER PROGRAMMING FROM TELEPHONE	Call, wait for tone then enter MASTER PASSWORD
ESCAPE/CANCEL	*
EXIT PROGRAMMING	99#

SYSTEM OPTIONS

USAGE	PROGRAM POSITION NUMBER
CHANGE MASTER PASSWORD	PPN 01
DIRECTORY NUMBER LENGTH	PPN 02
ENTRY CODE LENGTH	PPN 03
SYSTEM DISPLAY LANGUAGE	PPN 04
KEYPAD LOCKOUT COUNT	PPN 51
RELAY ACTIVATION TIME	PPN 52
RELAY CHANNEL "B" FUNCTION	PPN 53
SENSING INPUT FUNCTION	PPN 54
MGT OBSTACLE TRANSMITTER SETUP	PPN 55
WELCOME DISPLAY TEXT	PPN 57
TELEPHONE KEY ASSIGNMENTS FOR RESIDENTS	PPN 58
AUTOMATIC TELEPHONE ANSWER	PPN 61
SPEAKER CHIRP ON KEYSTROKES	PPN 62
SPEAKER TONE ON RELAY CHANNEL "A" ACTIVATION	PPN 63
SET MAXIMUM VISITOR TALK TIME	PPN 64
SET DIRECTORY LIST START POSITION	PPN 65
SET UNIT NUMBER	PPN 71

ACCESS MEDIA CONTROL

USAGE	PROGRAM POSITION NUMBER
ADDING A RESIDENT	PPN 21
MODIFY A RESIDENT	PPN 22
DELETING A RESIDENT	PPN 23
ADDING AN ENTRY CODE	PPN 31
MODIFYING AN ENTRY CODE	PPN 32
DELETING AN ENTRY CODE	PPN 33
ASSIGN BLOCK TRANSMITTER	PPN 41
SUSPEND A TRANSMITTER	PPN 43
ACTIVATE A TRANSMITTER	PPN 42
TRANSMITTER BUTTON SETUP	PPN 44
ASSIGN A SINGLE ENROLLED TRANSMITTER	PPN 45
DELETE A SINGLE ENROLLED TRANSMITTER	PPN 47

SYSTEM UTILITIES

USAGE	KEYSTROKES
DISPLAY UNIT NUMBER	72#
DISPLAY SYSTEM FIRMWARE VERSION	73#
LATCH RELAY CHANNEL "A"	81#
LATCH RELAY CHANNEL "B"	82#
RELEASE RELAY CHANNEL "A"	83#
RELEASE RELAY CHANNEL "B"	84#
DELETE ALL RESIDENT DATA	92#000000#000000#
DELETE ALL ENTRY CODES	93#000000#000000#
DELETE ALL WIRELESS TRANSMITTERS	94#000000#000000#
TOTAL MEMORY RESET	200#000000#000000#

CUSTOM MASTER PASSWORD

Factory Settings

PPN #	FACTORY SETTING
PPN 01	MASTER PASSWORD 123456
PPN 02	DIRECTORY NUMBER LENGTH 3 DIGITS
PPN 03	ENTRY CODE LENGTH 4 DIGITS
PPN 04	SYSTEM DISPLAY LANGUAGE ENGLISH
PPN 31	ENTRY CODE RELAY SELECTION RELAY CHANNELS "A" & "B"
PPN 31	ENTRY CODE USAGE LIMIT UNLIMITED
PPN 44	TRANSMITTER BUTTON SETUP
	SINGLE BUTTON, LEFT (OR TOP LEFT) BUTTON ACTIVATES RELAY CHANNEL "A"
	RIGHT (OR TOP RIGHT) BUTTON ACTIVATES RELAY CHANNEL "B"
	TOP BUTTON ACTIVATES NO RELAY
	LOWER LEFT BUTTON ACTIVATES NO RELAY
	LOWER RIGHT BUTTON ACTIVATES NO RELAY
PPN 51	KEYPAD LOCKOUT COUNT 5 TRIES BEFORE LOCKOUT
PPN 52	RELAY CHANNEL "A" ON TIME 2 SECONDS
PPN 52	RELAY CHANNEL "B" ON TIME 2 SECONDS
PPN 53	RELAY CHANNEL "B" FUNCTION NORMAL ACCESS
PPN 54	SENSING INPUT FUNCTION DOOR SENSE
PPN 55	MGT OBSTACLE TRANSMITTER SETUP DEACTIVATED
PPN 57	WELCOME DISPLAY TEXT LINEAR ACCESS TELEPHONE ENTRY
PPN 58	TELEPHONE KEY ASSIGNMENTS FOR RESIDENTS
	TELEPHONE KEY 9 RELAY CHANNEL "A"
	TELEPHONE KEY 5 RELAY CHANNEL "B"
	TELEPHONE KEY * DISCONNECT VISITOR
PPN 61	AUTOMATIC TELEPHONE ANSWER ON
PPN 62	SPEAKER CHIRP ON KEYSTROKES ON
PPN 63	SPEAKER TONE ON RELAY CHANNEL "A" ACTIVATION OFF
PPN 64	MAXIMUM VISITOR TALK TIME 1 MINUTE
PPN 71	UNIT NUMBER 1

Programming Notes

For security, backing up a unit's data is always a good idea. When making programming changes, backups should be done frequently.

The following steps detail data backup and restore techniques used while programming with the AE-500's built-in programming interface and a personal computer.

Data Backup

To copy data from a unit to a backup file, follow these steps:

1. From the home page, click "Utilities".
2. Select "Data Backup".
3. Click "Save" at the XML warning window.
4. Select a file to save to and click "Save".

Data Restore

To copy data from a backup file to a unit, follow these steps:

1. From the home page, click "Utilities".
2. Select "Load Factory Defaults".
- ◆ **IMPORTANT NOTE:** *Always load the factory defaults into a unit before performing data restore. Otherwise, the unit's data may become corrupted.*
3. Click "Yes", then "Save".
4. When complete, click "Data Restore".
5. Browse for the file to copy.
6. Select the file and click "Upload" to send the file to the unit.

Setting Up Multiple Units

The system supports up to seven AE-500s connected to the same telephone line. Some telephone systems may only support up to four units on the same telephone line. In multiple-unit installations each AE-500 must be assigned a unique unit number before programming. The unit number allows connecting to a specific unit when calling for programming. One unit must be assigned as Unit #1.

- ◆ **NOTE:** If this is the only unit used in the installation, leave the factory setting at one. Skip this programming step.

Perform the following steps on each AE-500 unit **connected to the same telephone line**.

1. If not already in Programming Mode, use the local keypad to enter the master password and access programming.
2. Press: **7 1 #**
3. Enter the unit number (1-7).
4. Press **#**
5. Exit Programming Mode.

Multiple Unit Installation Programming Information

To computer program multi-unit installations that use the same telephone line, each unit will require a separate "Dial-up" connection.

Creating a Connection for Each Unit

1. Start creating a "Dial-up" connections for each unit as described on Page 13.
2. When the "New Connection Wizard" asks for the "Connection Name" (Step #6 in the Page 13 figure) enter a unique name for the specific unit.
Example: "AE-500 Unit #2"
3. When the "New Connection Wizard" asks for the "Phone Number to Dial" (Step # 7 in the Page 13 figure) enter the common telephone number for the multi-unit installation followed by four commas, the unit number, and a #.
Example: "555-1234,,,2#"

- ◆ **NOTE:** Each comma adds a 2-second delay to the dialing process. Depending on the time required by the telephone system to make a connection to the AE-500, more or less commas might be required.

4. When the "New Connection Wizard" is finished, a desktop icon named for each AE-500 unit will be created on the computer.

To connect to a specific unit for programming, double-click on the desktop icon named for the unit.

Copying Data from One Unit to Another

If multiple units will be sharing the same programming information, data from one unit can be copied to another. A backup file is created in this process to make copies. For security, backing up a unit's data is always a good idea.

1. After entering the Resident Data, Media Data, and programming options for the first unit, click "Utilities", then "Data Backup". Click "Save" at the XML warning window then select a file to save to.
2. After the data backup is complete, disconnect from the first unit, then reconnect to the unit to copy the data to.
3. From the home page, click "Utilities", then "Load Factory Defaults". When complete, click "Data Restore" and browse for the file to copy. Select the file and click "Upload" to send the file to the unit.

- ◆ **IMPORTANT NOTE:** Always load the factory defaults into a unit before performing data restore. Otherwise, the unit's data may become corrupted.
4. Make any other unit-specific programming changes before disconnecting.

Changing the Master Password

Use this programming step to change the six-digit Master Password. Be sure to write down the new code.

1. If not already in Programming Mode, connect by telephone or use the local keypad. Enter the master password and access programming.
2. Press: **0 1 #**
3. Enter the new 6-digit master password.
4. Press **#**
5. Enter the new 6-digit master password again.
6. Press **#**
7. Exit Programming Mode.

SETTING A UNIT NUMBER

PPN 71

71 #UNIT #

UNIT = UNIT NUMBER (1-7) FOR MULTI-UNIT INSTALLATION

FACTORY SETTING: UNIT NUMBER 1

CREATE A UNIQUE NAME FOR EACH UNIT IN THE MULTI-UNIT INSTALLATION

ADD DELAY COMMAS AFTER THE TELEPHONE NUMBER, THEN ENTER THE UNIT NUMBER AND A #

UTILITIES PAGE

CHANGING THE MASTER PASSWORD

PPN 01

01 #PASS #PASS #

PASS = THE NEW 6-DIGIT MASTER PASSWORD

FACTORY SETTING: 123456

Resident Data Programming

Up to 250 resident names and telephone numbers can be set. Each resident entry is assigned a directory number. The directory numbers are the numbers visitors enter to have the system call the residents.

- ◆ **NOTE:** When entering resident names, programming the AE-500 from a computer is the preferred method. Refer to the "Programming from the Local Keypad" section of these instructions for details on alphanumeric entry from the keypad.

Changing the Directory Number Length

The factory setting for the directory number length is 3 digits. It can be set to 2, 3, or 4 digits.

1. If not already in Programming Mode, connect by telephone or use the local keypad. Enter the master password and access programming.
2. Press **0 2 #**
3. Enter the directory number length (2, 3, or 4).
4. Press **#**
5. Exit Programming Mode if all programming is complete.

DIRECTORY NUMBER LENGTH

PPN 02

02#LENGTH#

LENGTH = NUMBER (2-4) OF DIRECTORY NUMBER DIGITS

FACTORY SETTING: 3 DIGITS

Adding a Resident

1. If not already in Programming Mode use the local keypad to enter the master password and access programming.
2. Press **2 1 #**
3. Enter the directory number that will be displayed for the resident.
4. Press **#**
- ◆ **NOTE:** To add the name using all capital letters, press **#** before entering the name.
5. Enter the name of the resident to be displayed (up to 16 characters).
6. Press **#**
7. Enter the resident's telephone number (up to 12 digits).
8. Press **#**
9. Exit Programming Mode if all programming is complete.

ADDING A RESIDENT

PPN 21

21#DIR#NAME#PHONE#

DIR = DIRECTORY NUMBER FOR THE RESIDENT
NAME = THE RESIDENT'S NAME (UP TO 16 CHARACTERS)
PHONE = THE RESIDENT'S TELEPHONE NUMBER (UP TO 12 DIGITS)

Modifying a Resident

Once resident data has been set, it can be modified to change a resident's name or telephone number.

1. If not already in Programming Mode, use the local keypad to enter the master password and access programming.
2. Press **2 2 #**
3. Enter the resident's directory number.
4. Press **#**
- ◆ **NOTE:** To modify the name using all capital letters, press **#** before entering the name.
5. Modify the name of the resident to be displayed (up to 16 characters), or to keep the name press **#** and skip to Step 6.
6. Press **#**
7. Modify the resident's telephone number (up to 12 digits) or skip to Step 8.
8. Press **#**
9. Exit Programming Mode if all programming is complete.

MODIFYING A RESIDENT

PPN 22

22#DIR#NAME#PHONE#

DIR = DIRECTORY NUMBER FOR THE RESIDENT
NAME = THE RESIDENT'S NAME (UP TO 16 CHARACTERS)
PHONE = THE RESIDENT'S TELEPHONE NUMBER (UP TO 12 DIGITS)

Deleting a Resident

Residents can be deleted individually.

1. If not already in Programming Mode, connect by telephone or use the local keypad. Enter the master password and access programming.
2. Press **2 3 #**
3. Enter the resident's directory number.
4. Press **#**
5. Enter the resident's directory number again.
6. Press **#**
7. Exit Programming Mode if all programming is complete.

DELETING A RESIDENT

PPN 23

23#DIR#DIR#

DIR = DIRECTORY NUMBER FOR THE RESIDENT

Entry Code Programming

An entry code is a number entered at the local or remote keypad to request access. Up to 500 entry codes from two to six digits in length can be set. All codes will be the same length. The factory setting allows the entry code to activate Relay Channel "A" or "B" depending on which keypad the code is entered on. Relay Channel "A" can only be controlled by the AE-500 keypad. Relay Channel "B" can only be controlled by a remote keypad. Each entry code can be set to restrict which relay activates. Entry codes can also be set to toggle the relay output (output latches on until the next time a toggle entry code is entered). Each entry code can be set for unlimited or limited number of uses.

Changing the Entry Code Length

The factory setting for the entry code length is 4 digits. It can be set to 2-6 digits.

1. If not already in Programming Mode, connect by telephone or use the local keypad. Enter the master password and access programming.
2. Press **0 3 #**
3. Enter the entry code length (2, 3, 4, 5, or 6).
4. Press **#**
5. Exit Programming Mode if all programming is complete.

Adding an Entry Code

1. If not already in Programming Mode, connect by telephone or use the local keypad. Enter the master password and access programming.
2. Press **3 1 #**
3. Enter the entry code.
4. Press **#**
5. Enter the entry code again.
6. Press **#**
7. If access to both relays is OK for this code, and the number of uses is unlimited, skip to Step 12.
8. Enter the number for the relay output(s) that this entry code will be allowed to activate or for toggle operation:
 - Enter 1 for Relay "A" • Enter 2 for Relay "B" • Enter 3 for Relays "A" & "B"
 - Enter 4 to toggle Relay "A" • Enter 5 for to toggle Relay "B"
9. Press **#**
10. If the number of uses is unlimited, skip to Step 12.
11. Enter the number of uses allowed (1-250).
12. Press **#**
13. Exit Programming Mode if all programming is complete.

Modifying an Entry Code

Once entry codes have been set, they can be modified to change the relay(s) to activate or the number of uses permitted.

1. If not already in Programming Mode, connect by telephone or use the local keypad. Enter the master password and access programming.
2. Press **3 2 #**
3. Enter the entry code.
4. Press **#**
5. Enter the number for the relay output(s) that this entry code will be allowed to activate or for toggle operation:
 - Enter 1 for Relay "A" • Enter 2 for Relay "B" • Enter 3 for Relays "A" & "B"
 - Enter 4 to toggle Relay "A" • Enter 5 for to toggle Relay "B"
6. Press **#**
7. If the number of uses is unlimited, skip to Step 9.
8. Enter the number of uses allowed (1-250).
9. Press **#**
10. Exit Programming Mode if all programming is complete.

Deleting an Entry Code

Entry codes can be deleted individually.

1. If not already in Programming Mode, connect by telephone or use the local keypad. Enter the master password and access programming.
2. Press **3 3 #**
3. Enter the entry code to delete.
4. Press **#**
5. Enter the entry code to delete again.
6. Press **#**
7. Exit Programming Mode if all programming is complete.

ENTRY CODE LENGTH

PPN 03

03#LENGTH#

LENGTH = NUMBER (2-6) OF ENTRY CODE DIGITS

FACTORY SETTING: 4 DIGITS

ADDING AN ENTRY CODE

PPN 31

31#CODE#CODE#RELAY#TEMP#

CODE = THE NEW ENTRY CODE

RELAY = 1 FOR RELAY "A"

RELAY = 2 FOR RELAY "B"

RELAY = 3 FOR RELAYS "A" AND "B"

RELAY = 4 TO TOGGLE RELAY "A" (ALTERNATES ON OR OFF)

RELAY = 5 TO TOGGLE RELAY "B" (ALTERNATES ON OR OFF)

TEMP = NUMBER OF USES ALLOWED (1-250)

FACTORY SETTING: RELAYS "A" & "B", UNLIMITED USE

MODIFYING AN ENTRY CODE

PPN 32

32#CODE#RELAY#TEMP#

CODE = ENTRY CODE TO MODIFY

RELAY = 1 FOR RELAY "A"

RELAY = 2 FOR RELAY "B"

RELAY = 3 FOR RELAYS "A" AND "B"

RELAY = 4 TO TOGGLE RELAY "A" (ALTERNATES ON OR OFF)

RELAY = 5 TO TOGGLE RELAY "B" (ALTERNATES ON OR OFF)

TEMP = NUMBER OF USES ALLOWED (1-250)

FACTORY SETTING: RELAYS "A" & "B", UNLIMITED USE

DELETING AN ENTRY CODE

PPN 33

33#CODE#CODE#

CODE = THE ENTRY CODE TO DELETE

Wireless Transmitter Programming

Up to 500 wireless transmitters can be used with the system. Transmitters can be ordered in pre-programmed blocks of sequential ID codes. Up to 16 blocks of transmitters can be used. Transmitter blocks can be ordered with a Facility Code of 1-15 for block identification if desired. Using Facility Codes is optional. For security, an individual transmitter can be deactivated in case it is lost or stolen.

- ◆ **NOTE:** Transmitters will activate Relay Channels "A" or "B" depending on the setting of the transmitter button options. See Transmitter Button Setup (PPN #44) in the System Options section of these instructions.

Assign Block Transmitter

Assigning a transmitter block assigns memory space for each block of transmitters used with the AE-500.

- ◆ **NOTE:** When a block of transmitters is assigned, all transmitters in the block will become active and ready to use.
1. If not already in Programming Mode, connect by telephone or use the local keypad. Enter the master password and access programming.
 2. Press **4 1** **⏏**
 3. Enter the number of transmitters in the block.
 4. Press **⏏**
 5. Enter the transmitter block's facility code.
 - ◆ **NOTE:** Facility codes are optional. Enter 0 to have the system ignore the transmitter block's facility code.
 6. Press **⏏**
 7. Enter the first (lowest) transmitter ID number for the block of transmitters.
 8. Press **⏏**
 9. Exit Programming Mode if all programming is complete.

ASSIGN BLOCK TRANSMITTER

PPN 41

41 #NUMBER#FC#ID#

NUMBER = NUMBER OF TRANSMITTERS IN THE BLOCK
FC = FACILITY CODE 0-15 (0 IF UNUSED)
ID = LOWEST TRANSMITTER ID NUMBER IN THE BLOCK

Assign Single Enrolled Transmitter

Assigning a transmitter allocates memory space for the transmitter

- ◆ **NOTE:** When a transmitter is assigned, it will become active and ready to use.
1. If not already in Programming Mode, connect by telephone or use the local keypad. Enter the master password and access programming.
 2. Press **4 5** **⏏**
 3. Enter the transmitter facility code (enter 0 if not used).
 4. Press **⏏**
 5. Enter the transmitter ID number of the transmitter
 6. Press **⏏**
 7. Exit Programming Mode if all programming is complete.

ASSIGN SINGLE ENROLLED TRANSMITTER

PPN 45

45#FC#ID#

FC = FACILITY CODE (0 IF UNUSED)
ID = TRANSMITTER ID NUMBER

Suspend a Transmitter

Transmitters may be suspended if necessary (such as when a transmitter is lost or stolen).

1. If not already in Programming Mode, connect by telephone or use the local keypad. Enter the master password and access programming.
2. Press **4 3** **⏏**
3. Enter the transmitter's facility code (enter 0 if not used).
4. Press **⏏**
5. Enter the transmitter's ID number.
6. Press **⏏**
7. Exit Programming Mode if all programming is complete.

SUSPEND A TRANSMITTER

PPN 43

43#FC#ID#

FC = FACILITY CODE 0-15 (0 IF UNUSED)
ID = TRANSMITTER ID NUMBER

Activate a Transmitter

If a transmitter has been suspended, it can be activated again with these programming steps.

1. If not already in Programming Mode, connect by telephone or use the local keypad. Enter the master password and access programming.
2. Press **4 2** **⏏**
3. Enter the transmitter's facility code (enter 0 if not used).
4. Press **⏏**
5. Enter the transmitter's ID number.
6. Press **⏏**
7. Exit Programming Mode if all programming is complete.

ACTIVATE A TRANSMITTER

PPN 42

42#FC#ID#

FC = FACILITY CODE 0-15 (0 IF UNUSED)
ID = TRANSMITTER ID NUMBER

Wireless Transmitter Programming (Continued)

Delete single Enrolled Transmitter

Delete a single enrolled transmitter from the system.

1. If not already in Programming Mode, connect by telephone or use the local keypad. Enter the master password and access programming.
2. Press **4 7 #**
3. Enter the transmitter facility code.
4. Press **#**
5. Enter the transmitter ID number of the transmitter.
6. Press **#**
7. Exit Programming Mode if all programming is complete.

DELETE SINGLE ENROLLED TRANSMITTER

PPN 47

47#FC#ID#

FC = FACILITY CODE (0 IF UNUSED)
ID = TRANSMITTER ID NUMBER

System Options

For most installations the factory settings for the system will be appropriate. To customize the system, enter programming mode via telephone or local keypad.

Display Language

Select the language of the front panel display.

1. Press 04#
2. Choose a language: Enter 1 for English, Enter 2 for Spanish, Enter 3 for French
3. Press #

DISPLAY LANGUAGE

PPN 04

04#VALUE#

VALUE = LANGUAGE VALUE
ENGLISH = 1, SPANISH = 2, FRENCH = 3

FACTORY SETTING: ENGLISH

Keypad Lockout Count

The system counts the number of invalid entry codes entered at the local or remote keypad. The factory setting for the lockout count is five. The lockout value can be from two to seven.

1. Press **5 1 #**
2. Enter the number for the lockout count (2-7).
3. Press **#**
4. Exit Programming Mode if all programming is complete.

KEYPAD LOCKOUT COUNT

PPN 51

51#COUNT#

COUNT = NUMBER (2-7) OF INCORRECT
ENTRIES REQUIRED FOR LOCKOUT

FACTORY SETTING: 5 TRIES

Relay Activation Time

The factory setting will cause the relays to activate for two seconds. The activation time can be set from 1-60 seconds to accommodate different types of access control devices.

1. Press **5 2 #**
2. Choose which relay to set:
 - Enter 1 for Relay Channel "A"
 - Enter 2 for Relay Channel "B"
3. Press **#**
4. Enter the number of seconds for activation (1-60).
5. Press **#**
6. Exit Programming Mode if all programming is complete.

RELAY ACTIVATION TIME

PPN 52

52#RELAY#SECONDS#

RELAY = 1 FOR RELAY CHANNEL "A"
RELAY = 2 FOR RELAY CHANNEL "B"
SECONDS = ACTIVATION TIME (1-60 SECONDS)

FACTORY SETTING: 2 SECONDS

Relay Channel "B" Function

Relay Channel "B" is normally used to control a second access device. Alternately, Relay Channel "B" can be used for alarm contact shunting, obstacle sensing output, or triggering audible alarms.

1. Press **5 3 #**
2. Enter a number for the Relay Channel "B" function:
 - Enter 0 for normal access control.
 - Enter 1 for Alarm Contact Shunt (Relay "B" will activate when Relay "A" activates).
 - Enter 2 for activation when an MGT obstacle transmitter triggers. Wire Relay "B" contacts to access device obstacle input (see PPN #55).
 - Enter 3 for triggering audible alarms on specific conditions.
3. Press **#**
4. If any number but 3 was entered above, skip to Step #8.
5. Enter the audible alarm option:
 - Enter 1 for forced entry activation (activates if the sensing input is set for Door Sense and detects an open access portal condition without access being granted by the system).
 - Enter 2 for door/gate ajar activation (activates if the sensing input is set for Door Sense and still detects an open access portal condition one minute after access was granted by the system).
 - Enter 3 for activation during local or remote keypad lockout.
6. Press **#**
7. Exit Programming Mode if all programming is complete.

RELAY CHANNEL "B" FUNCTION

PPN 53

53#FUNCTION#ALARM#

FUNCTION = 0 FOR NORMAL ACCESS CONTROL
FUNCTION = 1 FOR ALARM SHUNT
FUNCTION = 2 FOR MGT OBSTACLE TRANSMITTER
FUNCTION = 3 ALARM ON CONDITION
ALARM = 1 FOR ACTIVATE ON FORCED ENTRY
ALARM = 2 FOR ACTIVATE ON DOOR OR GATE AJAR
ALARM = 3 FOR ACTIVATE ON KEYPAD LOCKOUT

FACTORY SETTING: NORMAL ACCESS CONTROL

System Options (Continued)

Sensing Input Function

The Sensing Input (DS-A terminal) can be set for Door Sense or Access Inhibit.

- When the Sensing Input is used for “Door Sense”, the input connects to a switch that detects if the access portal is open or closed. Monitoring the portal status permits use of the alternate functions of Relay Channel “B” (PPN #53).
 - When the Sensing Input is used for “Access Inhibit” it will prevent access from being granted as long as the input is activated (DS-A terminal shorted to ground). This feature is useful when used with an external timer to limit granting access to a specific time period. It also can be used for a “service” switch to disable the access control system output during servicing.
1. If not already in Programming Mode, connect by telephone or use the local keypad. Enter the master password and access programming.
 2. Press **5 4** **⏏**
 3. Choose the Sensing Input (DS-A terminal) option:
 - Enter 0 for the DS-A terminal to act as Door Sense
 - Enter 1 for the DS-A terminal to act as Access Inhibit.
 4. Press **⏏**
 5. Exit Programming Mode if all programming is complete.

SENSING INPUT FUNCTION

PPN 54

54#INPUT TYPE#

INPUT TYPE = 0 FOR DOOR SENSE
INPUT TYPE = 1 FOR ACCESS INHIBIT

FACTORY SETTING: DOOR SENSE

MGT Obstacle Transmitter Setup

Linear’s Model MGT obstacle transmitter is compatible with the AE-500. The gate safety edge switch detects obstacles and MGT transmits the event to the AE-500. Obstacle signals from an MGT transmitter will activate Relay Channel “B”.

- ◆ **NOTE:** Be sure to set the Relay Channel “B” function to Option “2” when using an MGT obstacle transmitter. See Relay Channel “B” Function (PPN #53) in the System Options section of these instructions.

1. If not already in Programming Mode, connect by telephone or use the local keypad. Enter the master password and access programming.
2. Press **5 5** **⏏**
3. Select the status for the MGT transmitter:
 - Enter 1 to activate the transmitter.
 - Enter 0 to deactivate the transmitter.
4. Press **⏏**
5. Enter the MGT transmitter’s facility code (enter 0 if not used).
6. Press **⏏**
7. Enter the MGT transmitter’s ID number.
8. Press **⏏**
9. Exit Programming Mode if all programming is complete.

MGT OBSTACLE TRANSMITTER SETUP

PPN 55

55#STATUS#FC#ID#

STATUS = 1 TO ACTIVATE
STATUS = 0 TO DEACTIVATE
FC = FACILITY CODE 0-15 (0 IF UNUSED)
ID = MGT TRANSMITTER ID NUMBER 0-65535

FACTORY SETTING: DEACTIVATED

Telephone Key Assignments for Residents

Residents use their telephone keys to grant access to visitors.

The factory settings are:

- Key 9 assigned to Relay Channel “A”
- Key 5 assigned to Relay Channel “B”
- Key * disconnects the visitor’s call.

The resident’s telephone key numbers can be changed if desired.

1. If not already in Programming Mode, connect by telephone or use the local keypad. Enter the master password and access programming.
2. Press **5 8** **⏏**
3. Enter the telephone key number (0-9).
4. Press **⏏**
5. Enter a number to assign the key’s function:
 - Enter 1 to assign the key to Relay Channel “A”.
 - Enter 2 to assign the key to Relay Channel “B”.
 - Enter 3 to assign the key to disconnect the visitor’s call.
 - Enter 4 to disable the key.
6. Press **⏏**
7. Exit Programming Mode if all programming is complete.

TELEPHONE KEY ASSIGNMENTS FOR RESIDENTS

PPN 58

58#KEY#ACTION#

KEY = RESIDENT’S TELEPHONE KEY NUMBER
ACTION = 1 FOR RELAY CHANNEL “A”
ACTION = 2 FOR RELAY CHANNEL “B”
ACTION = 3 FOR VISITOR DISCONNECT
ACTION = 4 TO DISABLE THE KEY

FACTORY SETTING:
KEY 9 RELAY CHANNEL “A”
KEY 5 RELAY CHANNEL “B”
KEY * DISCONNECT

System Options (Continued)

Welcome Display Text

The AE-500 display will show a visitor a welcome message alternating with instructions on how to call a resident. The welcome message can be customized to suit the installation.

- ◆ *NOTE: When changing the welcome display, programming the AE-500 from a computer is the preferred method. Refer to the "Programming from the Local Keypad" section of these instructions for details on alphanumeric entry from the keypad.*

1. If not already in Programming Mode use the local keypad to enter the master password and access programming.
2. Press **5 7** **⏏**
3. Enter the new text for the top line of the display (up to 16 characters).
4. Press **⏏**
5. Enter the new text for the bottom line of the display (up to 16 characters).
6. Press **⏏**
7. Exit Programming Mode if all programming is complete.

WELCOME DISPLAY TEXT

PPN 57

57#LINE 1#LINE 2#

LINE 1 = UP TO 16 CHARACTERS TEXT
LINE 2 = UP TO 16 CHARACTERS TEXT

FACTORY SETTING: LINEAR ACCESS TELEPHONE ENTRY

Automatic Telephone Answer

The factory setting will allow the system to detect a ring signal on the telephone line and answer the call. The automatic answer feature can be turned off, although remote programming and remote control of the system will no longer be possible.

1. If not already in Programming Mode, connect by telephone or use the local keypad. Enter the master password and access programming.
2. Press **6 1** **⏏**
3. Select the option for automatic telephone answering:
 - Enter 0 to turn OFF automatic telephone answering.
 - Enter 1 to turn ON automatic telephone answering.
4. Press **⏏**
5. Exit Programming Mode if all programming is complete.

AUTOMATIC TELEPHONE ANSWER

PPN 61

61#ANSWER#

ANSWER = 0 FOR AUTO ANSWER OFF
ANSWER = 1 FOR AUTO ANSWER ON

FACTORY SETTING: AUTO ANSWER ON

Speaker Chirp on Keystrokes

The factory setting will cause the speaker to chirp when each key on the local keypad is pressed. The speaker chirp can be turned off.

1. If not already in Programming Mode, connect by telephone or use the local keypad. Enter the master password and access programming.
2. Press **6 2** **⏏**
3. Select the option for keystroke speaker chirps:
 - Enter 0 to turn OFF the keystroke speaker chirps.
 - Enter 1 to turn ON the keystroke speaker chirps.
4. Press **⏏**
5. Exit Programming Mode if all programming is complete.

SPEAKER CHIRP ON KEYSTROKE

PPN 62

62#CHIRP#

CHIRP = 0 FOR KEYSTROKE CHIRP OFF
CHIRP = 1 FOR KEYSTROKE CHIRP ON

FACTORY SETTING: KEYSTROKE CHIRP ON

Speaker Tone on Relay Channel "A" Activation

The factory setting will not cause the speaker to sound a tone when access is granted with Relay Channel "A". The tone can be turned on if desired.

1. If not already in Programming Mode, connect by telephone or use the local keypad. Enter the master password and access programming.
2. Press **6 3** **⏏**
3. Select the option for relay activation tone:
 - Enter 0 to turn OFF the relay activation tone.
 - Enter 1 to turn ON the relay activation tone.
4. Press **⏏**
5. Exit Programming Mode if all programming is complete.

SPEAKER TONE ON RELAY "A"

PPN 63

63#TONE#

TONE = 0 FOR RELAY TONE OFF
TONE = 1 FOR RELAY TONE ON

FACTORY SETTING: RELAY TONE OFF

System Options (Continued)

Maximum Visitor Talk Time

Visitors will converse with residents over the telephone until the resident grants or denies access. If the resident responds to the visitor's request by pressing their telephone keys the system will hang up and release the telephone line. If for some reason the resident does not press the telephone keys or does not hang up, the system will automatically disconnect the visitor after 60 seconds. The resident can extend the talk time by pressing the # key on their telephone. The disconnect time can be adjusted from 15-255 seconds.

1. If not already in Programming Mode, connect by telephone or use the local keypad. Enter the master password and access programming.
2. Press **6 4 #**
3. Enter the disconnect time in seconds (15-255):
4. Press **#**
5. Exit Programming Mode if all programming is complete.

MAXIMUM VISITOR TALK TIME

PPN 64

64#TIME#

TIME = TIME UNTIL AUTO-DISCONNECT
(15-255 SECONDS)

FACTORY SETTING: 60 SECONDS

Directory List Start Position

Although the directory is always sorted and displayed to visitors alphabetically, the initial directory entry displayed when # is pressed can be set to either the first directory entry or the directory entry in the middle of all directory entries, alphabetically.

1. If not already in Programming Mode, connect by telephone or use the local keypad. Enter the master password and access programming.
2. Press **6 5 #**
3. Select the option for the directory list start position.
 - Enter 0 to start at the first directory list
 - Enter 1 to start in the middle of the directory list
4. Press **#**
5. Exit Programming Mode if all programming is complete.

DIRECTORY LIST START POSITION

PPN 65

65#POS#

POS = 0 to show first directory entry
POS = 1 to show the middle directory entry

FACTORY SETTING: 1 (SHOW MIDDLE DIRECTORY ENTRY)

Transmitter Button Setup

Single and multi-button wireless transmitters can be used with the AE-500. The factory settings for the transmitter buttons are as follows:

- Single-button, Left (or top left on 4-button transmitters) activate Relay Channel "A"
- Right (or top right on 4-button transmitters) activate Relay Channel "B"
- Top button on 2 or 4-button transmitters is disabled.
- Lower left on 4-button transmitters is disabled.
- Lower right on 4-button transmitters is disabled.

Use the following steps to customize the actions of the buttons on transmitters.

This will affect all transmitters used with the system.

1. If not already in Programming Mode, connect by telephone or use the local keypad. Enter the master password and access programming.
2. Press **4 4 #**
3. Enter the number for the button location to assign to a relay:
 - Enter 1 for the top left button.
 - Enter 2 for the top right button.
 - Enter 3 for the top button.
 - Enter 4 for the bottom left button.
 - Enter 5 for the bottom right button.
4. Press **#**
5. Enter the relay output option for the button selected:
 - Enter 0 to disable the button.
 - Enter 1 for Relay Channel "A".
 - Enter 2 for Relay Channel "B".
 - Enter 3 for Relay Channels "A" & "B".
6. Press **#**
7. Exit Programming Mode if all programming is complete.

TRANSMITTER BUTTON SETUP

PPN 44

44#BUTTON#RELAY#

BUTTON = 1 FOR SINGLE BUTTON, LEFT OR TOP LEFT BUTTON
 BUTTON = 2 FOR RIGHT OR TOP RIGHT BUTTON
 BUTTON = 3 FOR TOP BUTTON
 BUTTON = 4 FOR BOTTOM LEFT BUTTON
 BUTTON = 5 FOR BOTTOM RIGHT BUTTON
 RELAY = 0 FOR NONE
 RELAY = 1 FOR RELAY "A"
 RELAY = 2 FOR RELAY "B"
 RELAY = 3 FOR RELAYS "A" & "B"

PPN #44 TRANSMITTER BUTTON SETUP

SINGLE BUTTON, LEFT OR TOP LEFT BUTTON:

- NO RELAY
- RELAY "A" (FACTORY SETTING)
- RELAY "B"
- RELAYS "A" & "B"

RIGHT OR TOP RIGHT BUTTON:

- NO RELAY
- RELAY "A"
- RELAY "B" (FACTORY SETTING)
- RELAYS "A" & "B"

TOP BUTTON:

- NO RELAY (FACTORY SETTING)
- RELAY "A"
- RELAY "B"
- RELAYS "A" & "B"

BOTTOM LEFT BUTTON:

- NO RELAY (FACTORY SETTING)
- RELAY "A"
- RELAY "B"
- RELAYS "A" & "B"

BOTTOM RIGHT BUTTON:

- NO RELAY (FACTORY SETTING)
- RELAY "A"
- RELAY "B"
- RELAYS "A" & "B"

System Utilities

Several utility commands are available for the system. Utilities can be used to clear memory, display system information, and control the relays.

Display Unit Number

In multi-unit installations the unit number of each AE-500 can be displayed.

1. If not already in Programming Mode, use the local keypad to enter the master password and access programming.
2. Press **7 2 #**
3. The display will show the unit number for three seconds.
4. Exit Programming Mode if all programming is complete.

Display System Firmware Version

The version of the firmware installed in the system can be displayed.

1. If not already in Programming Mode, use the local keypad to enter the master password and access programming.
2. Press **7 3 #**
3. The display will show the firmware version.
4. Exit Programming Mode if all programming is complete.

Manual Control of the Relays

For servicing or testing, each relay output can be controlled manually from the local keypad while in Programming Mode.

1. If not already in Programming Mode, use the local keypad to enter the master password and access programming.
2. Enter a command to control a relay:
 - Press **8 1 #** to latch Relay Channel "A".
 - Press **8 2 #** to latch Relay Channel "B".
 - Press **8 3 #** to release Relay Channel "A".
 - Press **8 4 #** to release Relay Channel "B".
3. The display will show the unit number for three seconds.
4. Exit Programming Mode if all programming is complete.

Deleting Database Entries

Sections of the database can be deleted individually. **Exercise care when using these commands, their effect cannot be reversed.**

1. If not already in Programming Mode, connect by telephone or use the local keypad. Enter the master password and access programming.
2. Enter a command to delete database sections:
 - To delete **all** resident data:

9 2 # 0 0 0 0 0 0 # 0 0 0 0 0 0 #

- To delete **all** entry codes press:

9 3 # 0 0 0 0 0 0 # 0 0 0 0 0 0 #

- To delete **all** wireless transmitters press:

9 4 # 0 0 0 0 0 0 # 0 0 0 0 0 0 #

3. Exit Programming Mode if all programming is complete.

Total Memory Reset

This command will erase **all** data and restore the factory settings.

1. If not already in Programming Mode, use the local keypad to enter the master password and access programming.
2. Press:
2 0 0 # 0 0 0 0 0 0 # 0 0 0 0 0 0 #
3. Exit Programming Mode if all programming is complete.

DISPLAY UNIT NUMBER

PPN 72

72#

DISPLAY SYSTEM FIRMWARE VERSION

PPN 73

73#

LATCH RELAY CHANNEL "A"

PPN 81

81#

LATCH RELAY CHANNEL "B"

PPN 82

82#

RELEASE RELAY CHANNEL "A"

PPN 83

83#

RELEASE RELAY CHANNEL "B"

PPN 84

84#

DELETE ALL RESIDENT DATA

PPN 92

92#000000#000000#

DELETE ALL ENTRY CODES

PPN 93

93#000000#000000#

DELETE ALL WIRELESS TRANSMITTERS

PPN 94

94#000000#000000#

TOTAL MEMORY RESET

PPN 200

200#000000#000000#

System Adjustments

The factory settings are sufficient for most installations. The system can be adjusted to customize the installation.

System Tone Adjustment

The sound level of the tones that the system produces can be adjusted.

1. Locate the **TONE VOLUME** adjustment on the main circuit board.
2. Press keys on the keypad while adjusting the **TONE VOLUME** until the tones are at the desired level. Turn the adjustment *clockwise* for more volume, *counterclockwise* for less volume.

Speaker Volume Adjustment

If the resident's voice from the speaker is too loud or not loud enough, the speaker's volume can be adjusted.

1. Locate the **SPEAKER VOLUME** adjustment on the main circuit board.
2. Make a directory number call to test the speaker volume. While listening to the resident's voice, turn the adjustment *clockwise* for more volume, *counterclockwise* for less volume.

Display Contrast Adjustment

If the lighting in the area or the viewing angle of the display in the installation causes the display to look too dark or too light, the display's contrast can be adjusted.

1. Locate the **DISPLAY CONTRAST** adjustment on the main circuit board.
2. Turn the adjustment clockwise and counterclockwise until display has the best visibility.

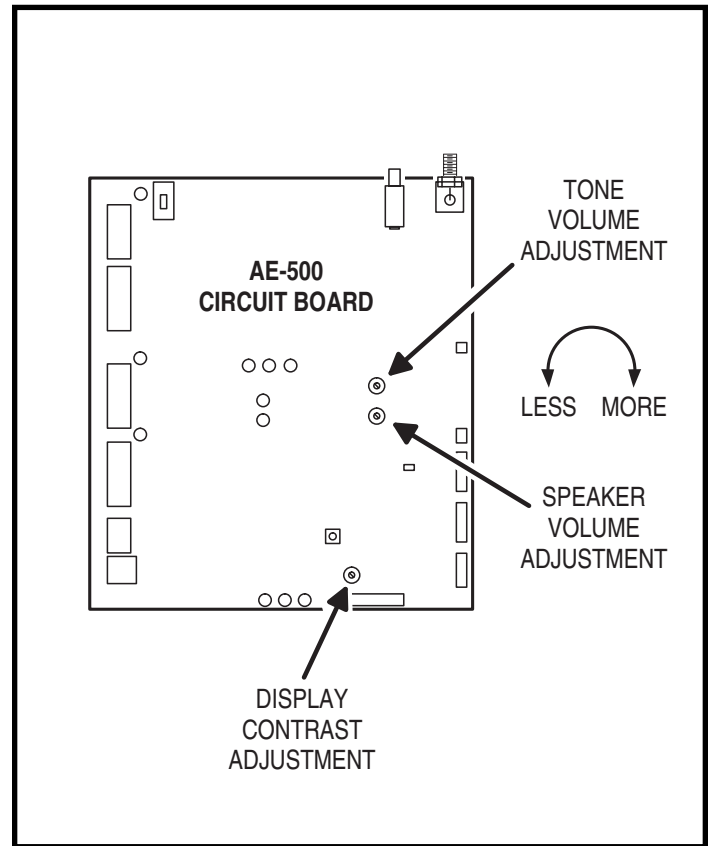

System Diagnostics

Several components on the main circuit board are for monitoring the system during operation. When calling for technical assistance, Linear's Technical Services Department may ask the installer to use these components to diagnose the system.

On-board Indicators

Eleven LED indicators are on the main circuit board. Refer to the figure for the location of each indicator.

- **POWER** lights when power is present at the power terminals.
- **RELAY CHANNEL "A"** lights when the Channel "A" relay is energized.
- **RELAY CHANNEL "B"** lights when the Channel "B" relay is energized.
- **DATA DCD** (Data Carrier Detect) lights when the built-in modem is detecting a carrier signal from the calling modem.
- **DATA RX** (Receive Data) lights when the built-in modem is receiving data from the calling modem.
- **DATA TX** (Transmit Data) lights when the built-in modem is sending data to the calling modem.
- **RADIO** lights when the system's radio receiver is detecting a transmitter signal or interference.
- **AC POWER FAIL** blinks if the system is running on DC without any AC present.
- **PBUS** blinks when data to the remote keypad is received or sent.
- **OFF-HOOK** lights when the system has the incoming telephone line seized.
- **TALK** lights when the system is communicating over the telephone line.

System Restart Button

Pressing the **SYSTEM RESTART** button will reboot the system's microcontroller. NO SYSTEM INFORMATION WILL BE ERASED.

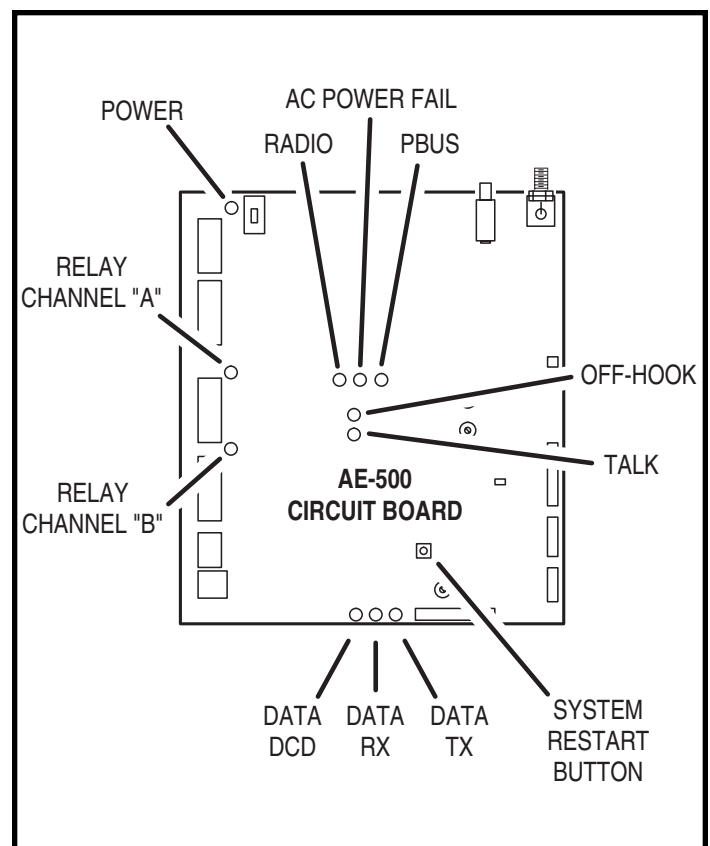

AE-500 Operation







Requesting Access with an Entry Code

- Residents/authorized personnel have up to 40 seconds to key in their entry code.
- Up to eight seconds are allowed between each keystroke.
- All digits of the entry code must be entered. Example: If the entry code length is set for four digits, and the code is 0042, the user must enter "0 0 4 2".
- If the wrong key is pressed, pressing the  key will reset the keypad. The correct code can then be re-entered.
- After a correct code is entered, and if the conditions for granting access are fulfilled, the programmed relay channel will activate for the programmed time.
- If the number of incorrect codes entered exceeds the keypad lockout count, the keypad will be locked and not accept any entries for one minute.

Requesting Access with a Wireless Transmitter

- Activate a wireless transmitter within radio range of the AE-500's antenna.
- After a valid transmitter is decoded, and if the conditions for granting access are fulfilled, the programmed relay channel will activate for the programmed time.

Requesting Access with a Visitor Call

- Press  to view the directory.
- If the visitor already knows the resident's directory number, they can enter the directory number to call the resident.
- If the visitor doesn't know the residents directory number, they can scroll through the alphabetical directory entries by pressing  or  (holding down the keys will scroll the display faster). To facilitate a faster search, the directory search will begin in the middle. The visitor can search forward or backward from there.
- When the visitor finds the resident's directory number, they enter it on the keypad to call the resident.
- The system dials the resident's telephone number to establish 2-way communications.
- ◆ **NOTE:** The resident's telephone number will never be displayed to the visitor.
- The resident answers the call and converses with the visitor to determine if access will be granted.
- The resident can use their telephone's keypad to grant access activating Relay Channel "A" by pressing : , or activating Relay Channel "B" by pressing . After access is granted, the system will disconnect the visitor and resident call.
- The resident can disconnect the visitor without granting access by pressing  or by hanging up.
- ◆ **NOTE:** The telephone keys that the resident presses can be customized for the installation. See Telephone Key Assignments for Residents (PPN #58) in the System Options section of these instructions.
- The length of time the visitor is allowed to talk can be programmed from 15-255 seconds. The resident will hear a series of beeps during the last 10 seconds of talk time. To restart the talk timer, the resident can press  on their telephone.

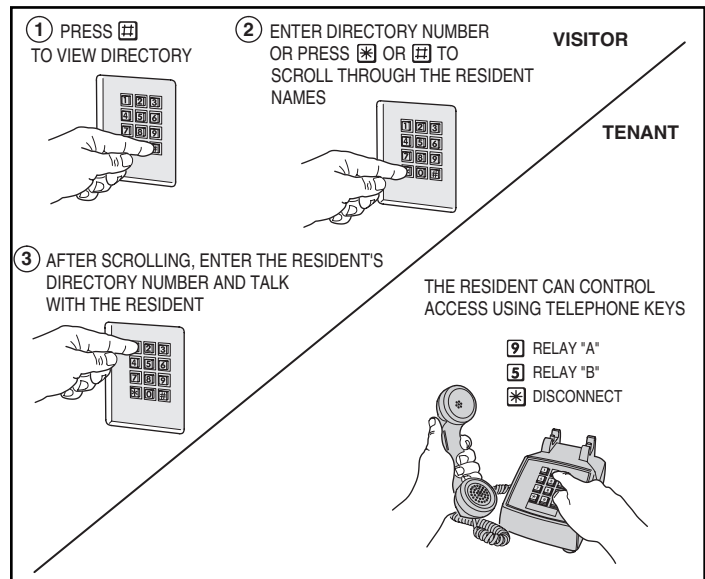
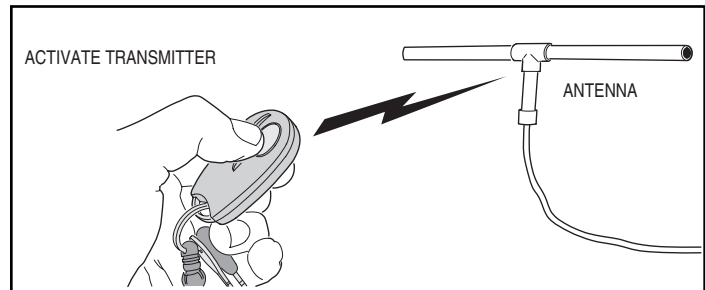
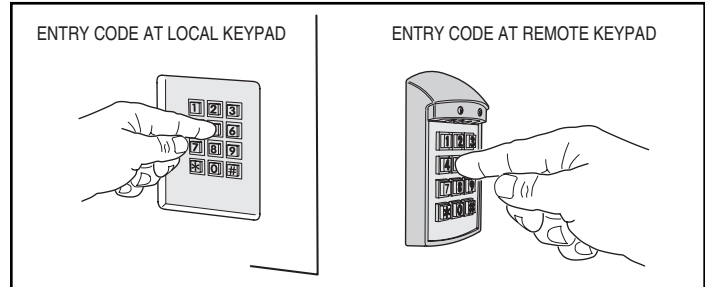

Specifications

MECHANICAL

Case dimensions: 10-3/4" W x 12-3/4" H x 3-1/2" D

ELECTRICAL

Voltage: 12-24 Volts AC/DC

Current: 500 mA DC typical, 750 mA DC maximum

Backup Battery: Externally charged 12 Volt DC source

Outputs: Relay Channels A & B

Form "C" 3 Amps @ 30 Volts maximum

Inputs: One sensing input

Two exit request inputs

RADIO

Frequency: 318 Mhz ± 500 KHz @ 23°C

RF 3db Bandwidth: 4 MHz Typical

Sensitivity: Adjustable, -97 dBm Minimum (-100 dBm Typical)

Encoding: Linear MegaCode® Format

ENVIRONMENTAL

Temperature: -22°F to 149°F (-30°C to 65°C)

Humidity: 5% to 95% non-condensing

SYSTEM

Relay On Time: 0-60 seconds, latch on-off

Interkey Time: 8 seconds maximum

Code Entry Time: 48 seconds maximum for 6-digit codes

Modem Baud Rate: 14.4 Kbps

Dimension Drawing

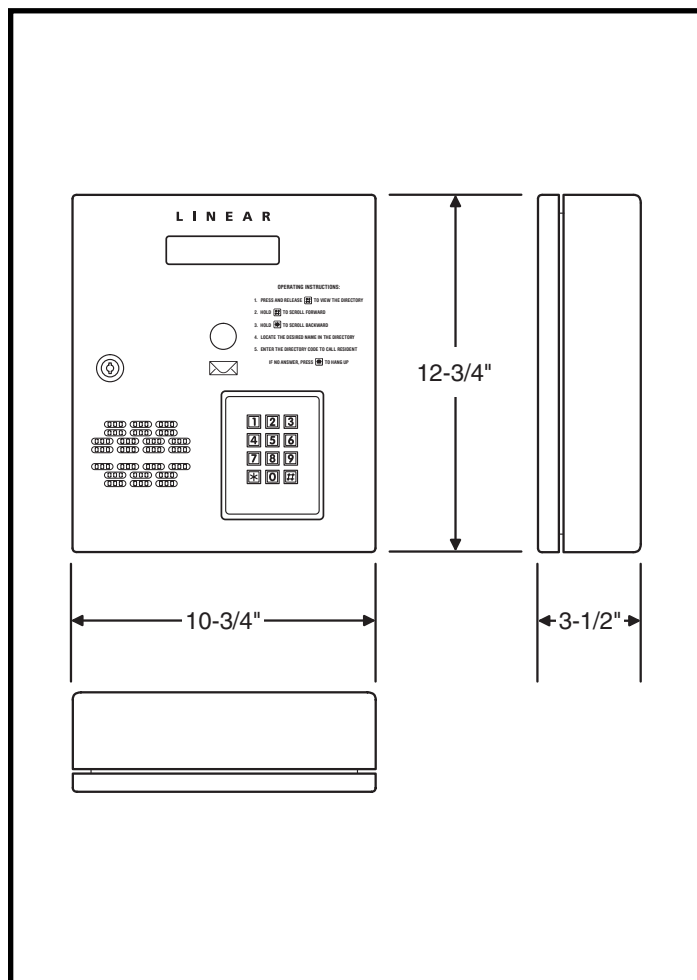

Troubleshooting

System completely dead

1. No power from transformer. Check voltage at AE-500 transformer terminals.
2. Verify that terminal blocks are firmly plugged into circuit board.

Buzz on speaker

1. Check for 24 volt AC power shorted to wiring conduit.
2. Check for telephone line shorted to ground.
3. Verify that telephone wires are twisted pair.
4. Verify that the AE-500 is connected to earth ground.
5. Check 16 VAC voltage at AE-500 transformer terminals.

Buzz on telephone line

1. Disconnect 16 VAC wires from terminal strip, if buzz goes away, one side of the transformer wires is grounded.
2. Check all connections for any shorts to ground.

System will not answer an incoming call

1. Automatic telephone answer disabled.
2. AE-500 telephone line trouble.

Entry code will not activate relay

1. Entry code not set up for proper relay.

Remote keypad does not work

1. Remote keypad address is not set to "1".
2. Check remote keypad indicator for power.

Main or remote keypad will not activate a relay

1. Entry code is not assigned.
2. Keypad may be in lockout from too many incorrect attempts. Wait one minute for lockout to clear and try again.

Resident's Telephone does not ring when a visitor calls

1. Resident's telephone number programmed incorrectly.
2. Check AE-500 telephone line.
3. Call resident from another line or cell phone to determine if the resident's telephone is working.

Transmitter does not activate relay

1. Transmitter button setting programmed to "no relay" (would effect all transmitters).
2. Transmitter block not enrolled.
3. Specific transmitter is deactivated in the system.

Poor transmitter radio range

1. Check antenna installation and condition if transmitters were previously working well.
2. Check the **RADIO** indicator on the AE-500 circuit board. If it is flickering without activating any transmitters there is interference blocking the receiver. Try adjusting the **RECEIVER RANGE** knob to reduce the receiver's sensitivity to the interference.
3. Connect an audio amplifier or telephone buttset to the **RECEIVER TEST POINTS** (the wire jumpers next to the **RECEIVER RANGE** knob). Listen to the sounds of the signals being received. If you hear the interference, remove power from possible interfering devices to determine the source of the interference. The antenna or the interfering device may need to be relocated.

Cannot restore system data

1. Sun Java must be installed.
2. From the Browser window, select Tools> Internet Options > Advanced.
3. Scroll down to "Java (Sun)" and check Use Java XX box (XX may vary with your browser version).

Linear Limited Warranty

This Linear product is warranted against defects in material and workmanship for twenty-four (24) months. The Warranty Expiration Date is labeled on the product. This warranty extends only to wholesale customers who buy direct from Linear or through Linear's normal distribution channels. Linear does not warrant this product to consumers. Consumers should inquire from their selling dealer as to the nature of the dealer's warranty, if any. **There are no obligations or liabilities on the part of Linear LLC for consequential damages arising out of or in connection with use or performance of this product or other indirect damages with respect to loss of property, revenue, or profit, or cost of removal, installation, or reinstallation.** All implied warranties, including implied warranties for merchantability and implied warranties for fitness, are valid only until Warranty Expiration Date as labeled on the product. **This Linear LLC Warranty is in lieu of all other warranties express or implied.**

All products returned for warranty service require a Return Product Authorization Number (RPA#). Contact Linear Technical Services at 1-800-421-1587 for an RPA# and other important details.

FCC Notice

Changes or modifications not expressly described in this manual or approved by the manufacturer could void the user's authority to operate the equipment.

This equipment has been tested and found to comply with the limits for a Class B digital device, pursuant to Part 15 of the FCC Rules. These limits are designed to provide reasonable protection against harmful interference in a residential installation. This equipment generates, uses and can radiate radio frequency energy and, if not installed and used in accordance with the instructions, may cause harmful interference to radio communications. However, there is no guarantee that interference will not occur in a particular installation. If this equipment does cause harmful interference to radio or television reception, which can be determined by turning the equipment off and on, the user is encouraged to try to correct the interference by one or more of the following measures:

- Reorient or relocate the receiving antenna.
- Increase the separation between the equipment and receiver.
- Connect the equipment into an outlet on a circuit different from that to which the receiver is connected.
- Consult the dealer or an experienced radio/TV technician for help.

