



Sliding Gate Installation Manual

Eagle-2000 Series

Eagle-1000 Series

Eagle Access Control Systems, Inc.

(800)708-8848

www.eagleoperators.com

Operator installation and instructions for the
Eagle-2000 and Eagle-1000 Series.

Eagle-1000

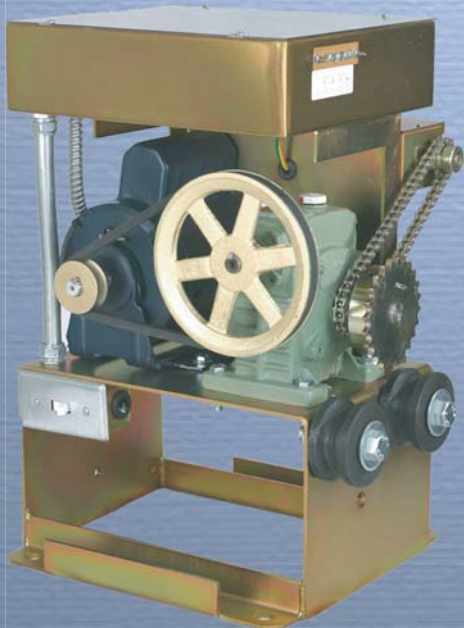

Eagle-2000

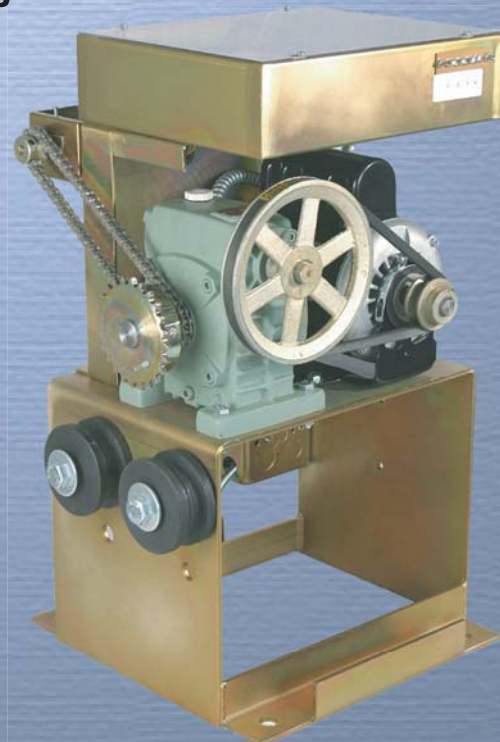

UL325 and UL991 Compliant

Table of Contents

Contents:	Page(s):
UL Listings	Page 3/4
Installing the Warning Sign / Precautions	Page 5
Instructions on Gate Posts	Page 6
Positive Stops	Page 6
Methods of Installation	Page 7
Proper Chain Installation	Page 7
Mounting Operator(s) to Concrete Pads	Page 8
Selecting the Opening Direction of Gate	Page 8
Connecting the Power	Page 9
Reverse / Exit Loop Installations	Page 9
Two Way Adjustable Reverse Sensors / ERD	Page 10
The Feature Selector	Page 11/12
Master and Slave Operation	Page 13
Master Control	Page 13
Slave Control	Page 14
Selecting the Delay Functions	Page 14
Describing the Output Connections	Page 15
MAG Lock Solenoid	Page 15
Alarm	Page 15
24 VAC Auxiliary Power	Page 15
Connecting the Accessories	Page 16
Description of Inputs	Page 17
Receiver Connections	Page 18
Gate Travel Distance / Setting the Limit Switches	Page 18
Emergency Releases	Page 19
Mounting the Secondary Entrapments	Page 20
Resetting the Motor	Page 20
Control Board LED Indicators	Page 21
Troubleshooting	Page 22
Parts Breakdown / Eagle-2000	Page 23
Parts Breakdown / Eagle-1000	Page 24
Operator Parts List / Eagle-2000 & Eagle-1000	Page 25

© 2002 Eagle Access Control Systems, Inc.

All rights reserved. No part of this manual may be reproduced in any means: graphics, electronics, or mechanical, including photocopying without the expressed written permission of the publisher. Materials, components and specifications are subject to change without notice.

UL Listings

Gate Operators Installation Instructions

- 1) Install the gate operator only when:
 - The operator is appropriate for the construction and the usage Class of the gate.
 - All openings of a horizontal slide gate are guarded or screened from the bottom of the gate to a minimum of 4 feet (1.2 m) above the ground to prevent a 2 ¼ inch (57.15 mm) diameter sphere from passing through the openings anywhere in the gate, and in that portion of the adjacent fence that the gate covers in the open position.
 - All exposed pinch points are eliminated or guarded.
 - Guarding is supplied for exposed rollers.
- 2) The operator is intended for installation only on gates used for vehicles. Pedestrians must be supplied with a separate access opening.
- 3) The gate must be installed in a location so that enough clearance is supplied between the gate and adjacent structures when opening and closing to reduce the risk of entrapment. Swinging gates shall not open into public access areas.
- 4) The gate must be properly installed and work freely in both directions prior to the installation of the gate operator.
- 5) Controls must be far enough from the gate so that the user is prevented from coming in contact with the gate while operating the controls. Controls intended to be used to reset an operator after two sequential activations of the entrapment protection device(s) must be located in the line of sight of the outdoor gate or easily accessible controls shall have a security feature to prevent unauthorized use.
- 6) All warning signs and placards must be installed where visible in the area of the gate.
- 7) For a gate operator utilizing a non-contact sensor such as a photo beam:
 - See instructions on the placement of non-contact sensor for each type of application.
 - Care shall be given to reduce the risk of nuisance tripping such as when a vehicle trips the sensor while the gate is still moving.
 - One or more non-contact sensors shall be located where the risk of entrapment or obstruction exists, such as the perimeter reachable by a moving gate or barrier.
- 8) Gate operators utilizing a contact sensor such as an edge sensor:
 - One or more contact sensors shall be located at the leading edge, trailing edge, and post mounted both inside and outside of a vehicular horizontal sliding gate.
 - One or more contact sensors shall be located at the bottom edge of a vehicular lift gate.
 - One or more contact sensors shall be located at the pinch point of a vehicular vertical pivot gate.
 - A hard wire contact sensor shall be located and its wiring arranged so that the communication between the sensor and the gate operator is not subject to mechanical damage.
 - A wireless contact sensor such as one that transmits radio frequency (RF) signals to the gate operator for entrapment protection functions shall be located where the transmission of the signals are not obstructed or impeded by building structure, natural landscaping, or similar obstruction. A wireless contact sensor shall function under the intended end use conditions.

UL Listings

Essential Safety Procedures

WARNING - TO REDUCE THE RISK OF INJURY OR DEATH - READ AND FOLLOW ALL INSTRUCTIONS:

- Never let children operate or play with gate controls. Keep the remote control away from children.
 - Always keep people and objects away from gate while the gate is in operation. **NO ONE SHOULD CROSS THE PATH OF A MOVING GATE.**
 - Test the gate operator monthly. The gate must reverse on contact with a rigid object or stop when an object activates the non-contact sensors. After adjusting the force or the limit of travel, retest the gate operator. Failure to adjust and retest the gate operator properly can increase the risk of injury or death.
 - Use the emergency release only when the gate is not moving. Make sure the power for the gate operator is off.
 - **KEEP GATES PROPERLY MAINTAINED.** Read and follow the manual. Have a qualified service person make repairs to the gate or gate hardware.
 - The entrance is for vehicles only. Pedestrians must use separate entrance.
- BE SURE TO CONTINUE TO KNOW AND PRACTICE THESE INSTRUCTIONS ●

UL Listings

Vehicular horizontal slide-gate operator (or system) - A vehicular gate operator (or system) that controls a gate which slides in a horizontal direction that is intended for use for vehicular entrance or exit to a drive, parking lot, or the like.

Gate - A moving barrier such as a swinging, sliding, raising, lowering, rolling, or like barrier that is a stand-alone passage barrier or is that portion of a wall or fence system that controls entrance and/or egress by persons or vehicles and completes the perimeter of a defined area.

Residential vehicular gate operator - Class I - A vehicular gate operator (or system) intended for use in a home of one to four single family dwellings, or a garage or parking area associated therewith.

Commercial / General access vehicular gate operator - Class III - A vehicular gate operator (or system) intended for use in an industrial location, loading dock area, or other location not intended to service the general public.

Commercial / General access vehicular gate operator - Class II - A vehicular gate operator (or system) intended for use in a commercial location or building such as a multi-family housing unit (five or more single family units), hotel, garages, retail store, or other buildings servicing the general public.

Commercial / General access vehicular gate operator - Class IV - A vehicular gate operator (or system) intended for use in a guarded industrial location or buildings such as airport security area or other restricted access locations not servicing the general public, in which unauthorized access is prevented via supervision by security personnel.

Installing the Warning Sign

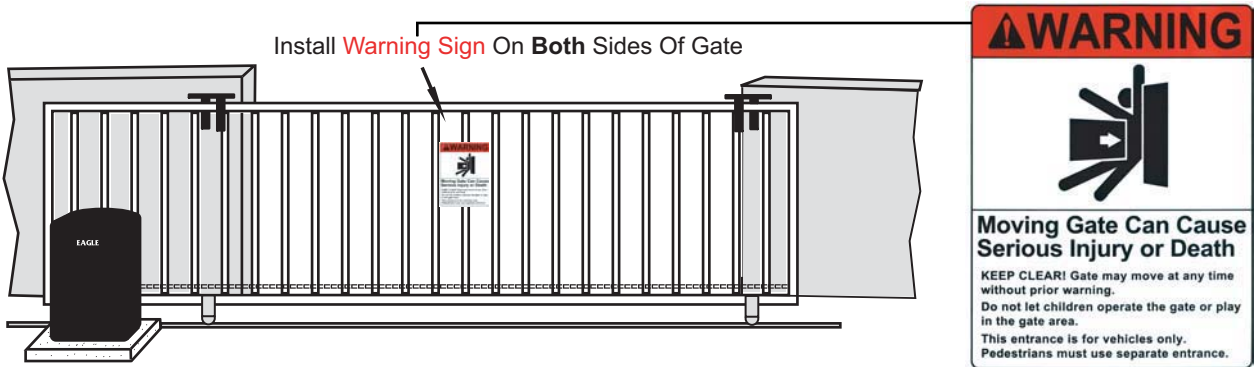

Precautions



Be sure to mount ALL operating devices clearly out of reach of through gate.

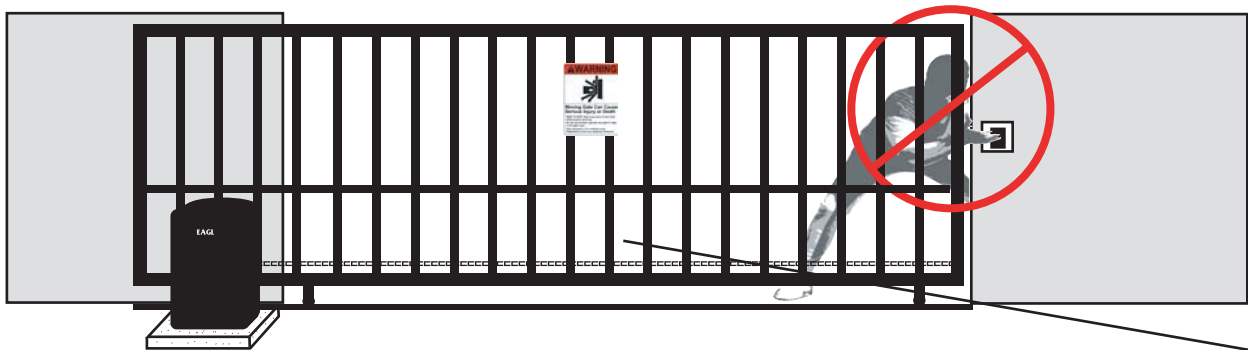

Regarding Ornamental Grill Styled Gates:

Injuries may be avoided if a mesh or screen is installed on the gate. Injuries resulting from hands and feet becoming stuck in gate or children riding the gate while in movement, can be greatly reduced if this "screen" or "mesh" is applied to gate as a safety precaution.

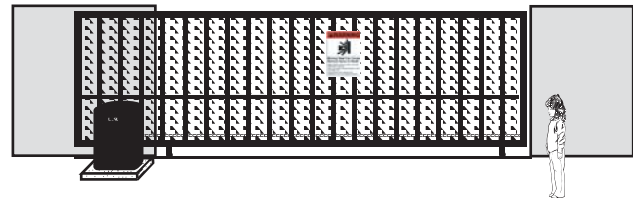

CAUTION!



Be sure to read and follow all the Eagle Access Control Systems, Inc. and UL instructions before installing and operating any Eagle Access Control Systems, Inc. products. Eagle Access Control Systems, Inc. is not responsible for any improper installation procedures caused by installer or user failing to comply with local building codes.

Instructions on Gate Posts

Important Notice!

Because the coasting distance may vary due to change in temperature, Eagle Access Controls does NOT recommend the installation of a stop or catch post in front of the gate path as shown in Example A. To do so will cause the gate to hit the post in certain instances. Eagle Access Controls only recommends installation of catch rollers on the side of a post with a minimal distance of 4" (Four inches) between the rollers as shown in Example B. Also when fully open the end of the sliding gate must stop at least 3" (three inches) from any wall or other objects as shown in Example C.

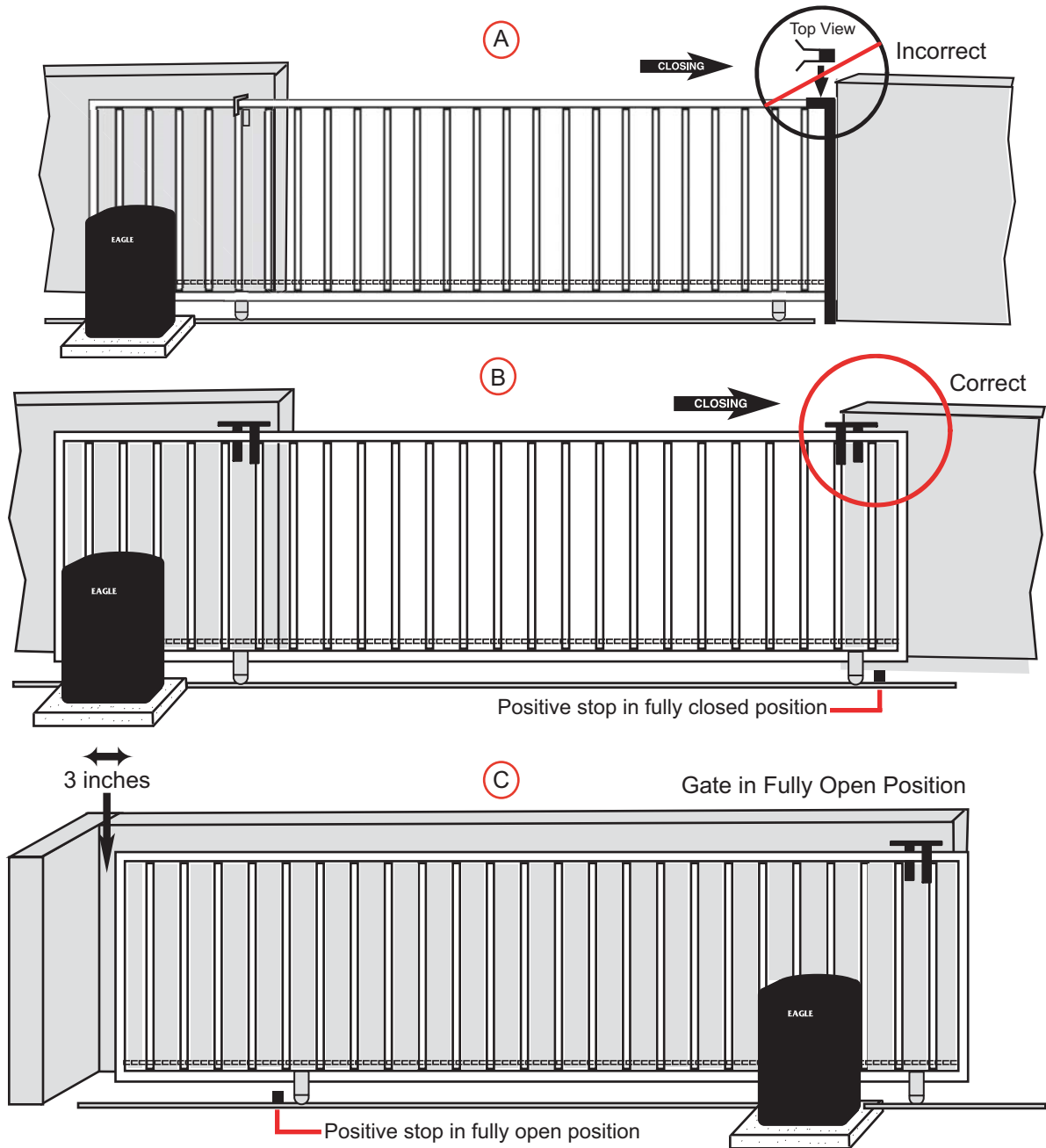

CAUTION!

Regarding Positive Stops

For safety reasons, a positive stop must be installed on the gate track prior to installation of the gate. This will assure that the gate does not exceed movement limit and derail while opening or closing fully.

Methods of Installation



It is highly recommended to install "over travel stops" at both ends of the gate rail in any type of installation in order to prevent derailing.

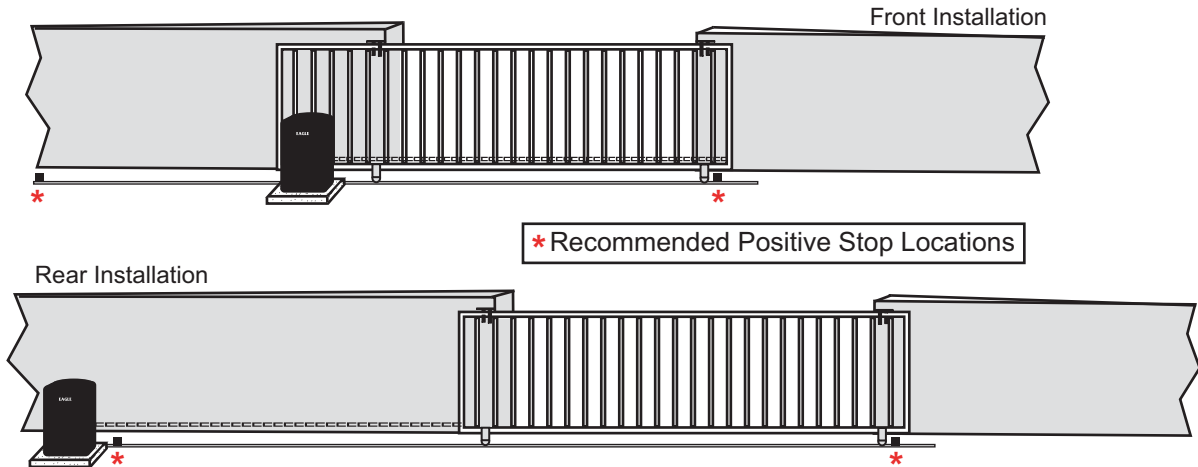

Proper Chain Installation

Minimum space between gate and output sprocket must be 4". After you position the gate operator, bolt-down the operator to the concrete bed. Make certain that the concrete bed is solid.

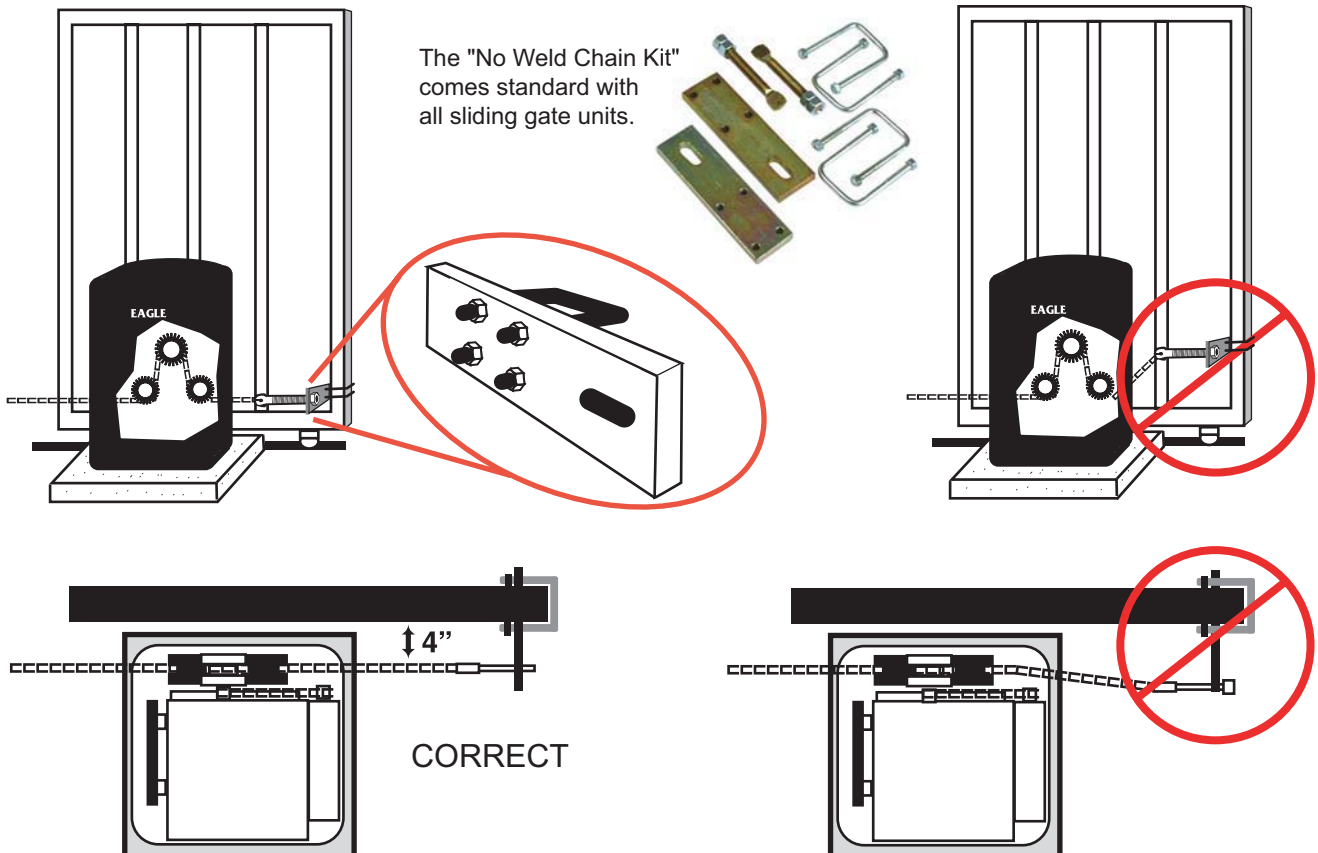

Mounting Operator(s) To A Concrete Pad



Be sure that the operator is installed in a level and paralleled position and is properly secured. Improper installation could result in property damage, severe injury, and/or death.

Note:

The following concrete recommendations are installation suggestions only. Please consult local codes for actual requirements in your area.

Recommended Dimensions

(Concrete Pad Diagram N.T.S.)

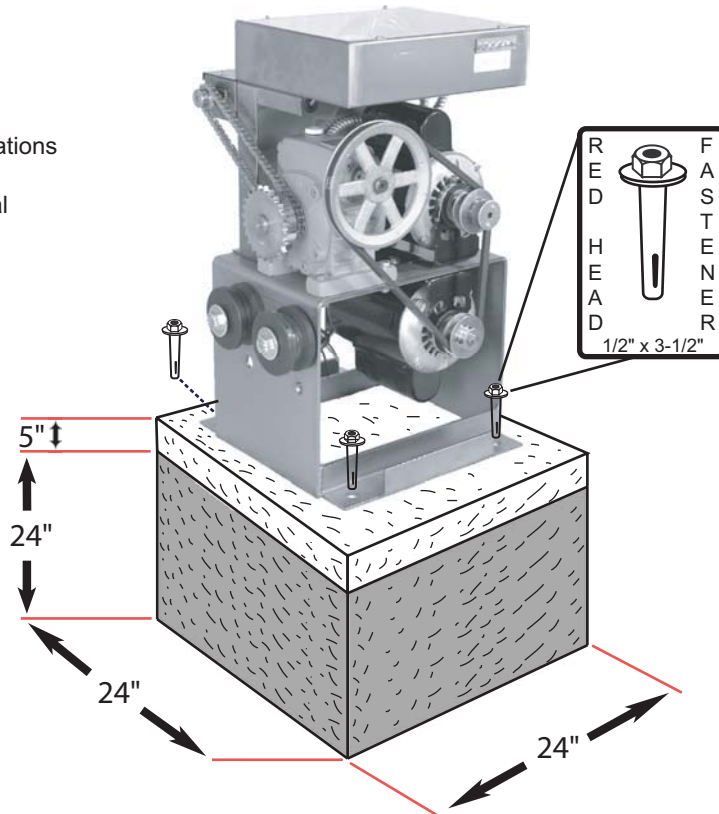

Selecting Opening Direction of Gate

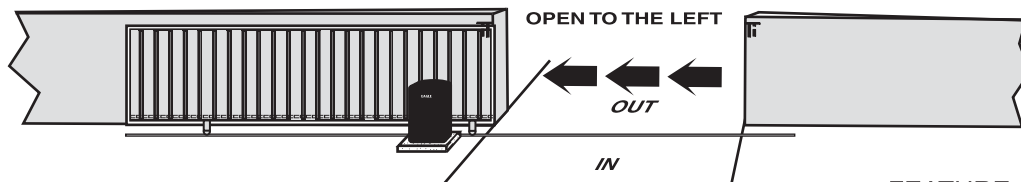

To select the opening direction of the gate, use the Feature Selector (as shown). Select switch #2 to the "open left" position for left opening. Use switch #2 to the "open right" position for right opening.

FEATURE SELECTOR

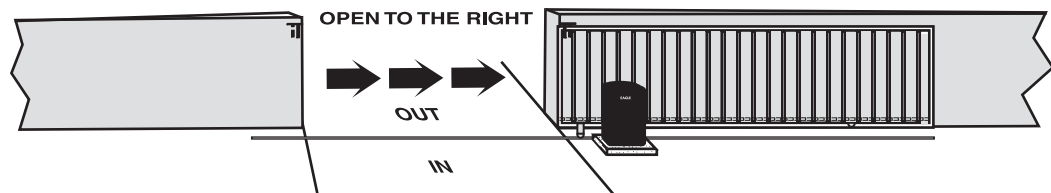
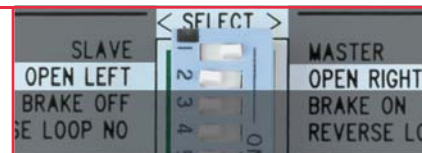

Connecting The Power



Be sure that the circuit breaker for the line input power is turned off before connecting the input power to the unit.

Connect 120 VAC, 15A, 60HZ, line input power to the wires provided in the power switch junction box located near the bottom of the operator.

Warning: Eagle Access Control Systems, Inc is not responsible for researching and complying with local building codes. Be sure to check into these codes before your installation.

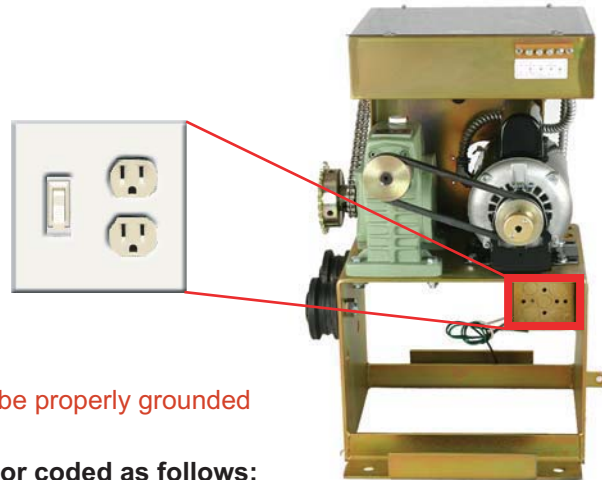

All units must be properly grounded

The wires are color coded as follows:

- Black - 120 VAC / Line Input Power
- White - Neutral Input
- Green - Ground Input (from an approved grounding method), the unit must be grounded

14 AWG	12 AWG	10 AWG	8 AWG	4 AWG
250 ft.	400 ft.	650 ft.	1000 ft.	2000 ft.

Reverse / Exit Loop Installation

The purpose of a reversing loop is to prevent the gate from closing on a vehicle while it is exiting or stopped in the middle of the gate area. The purpose of the exit loop is to automatically open the gate when a vehicle approaches to exit.

Exit Loop Operation

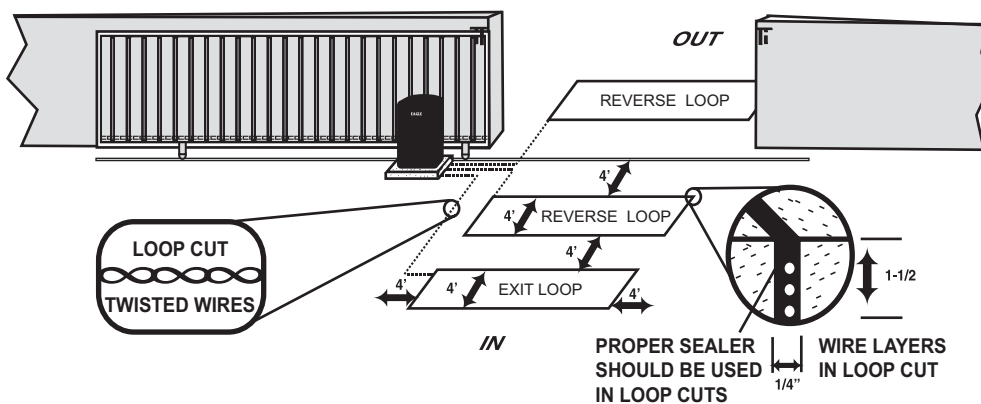

Wires must be wrapped inside the groove three times. Once you have completed the process, fill up the grooves with a proper seal.

Two Way Adjustable Reverse Sensor / ERD

CAUTION! 

Only a qualified service technician must make all adjustments to the sensor.

The Eagle Diamond Control Board has two separate pots for adjusting sensitivity. One is for opening the gate, and the other is for closing the gate.



IMPORTANT

The level of sensitivity has to do with the weight of the gate and the conditions of the installation.

There is an LED "OVERLOAD" warning that will light up when the gate is heavier than normal for the operator. During this warning, the operator will not function properly.

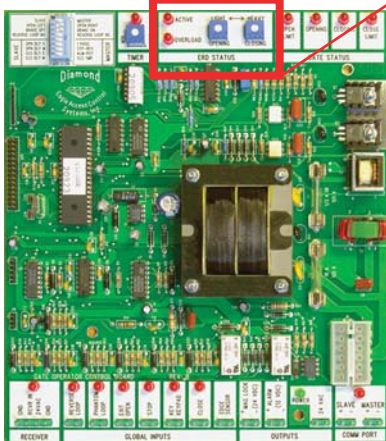

When Adjusting Sensors Remember...

Too Sensitive = if the gates stops or reverses by itself

Not Sensitive enough = if the gate strikes an object and does not stop or reverse

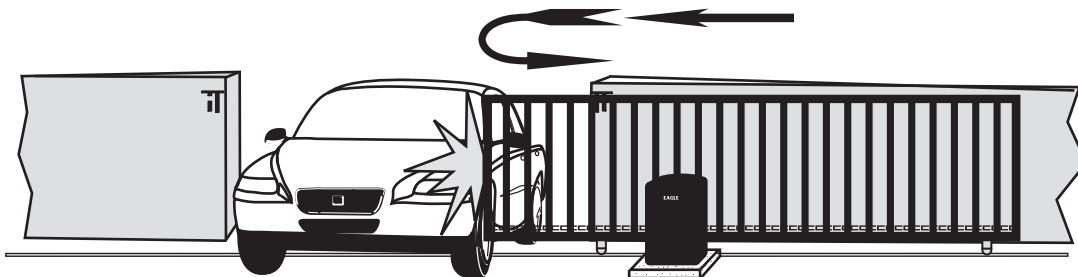

The Feature Selector

The selector uses an eight-station switch system that allows selection of the standard features and customized installation settings. The switch description is as follows:

Note: The power should always be turned off when designating feature selector switches

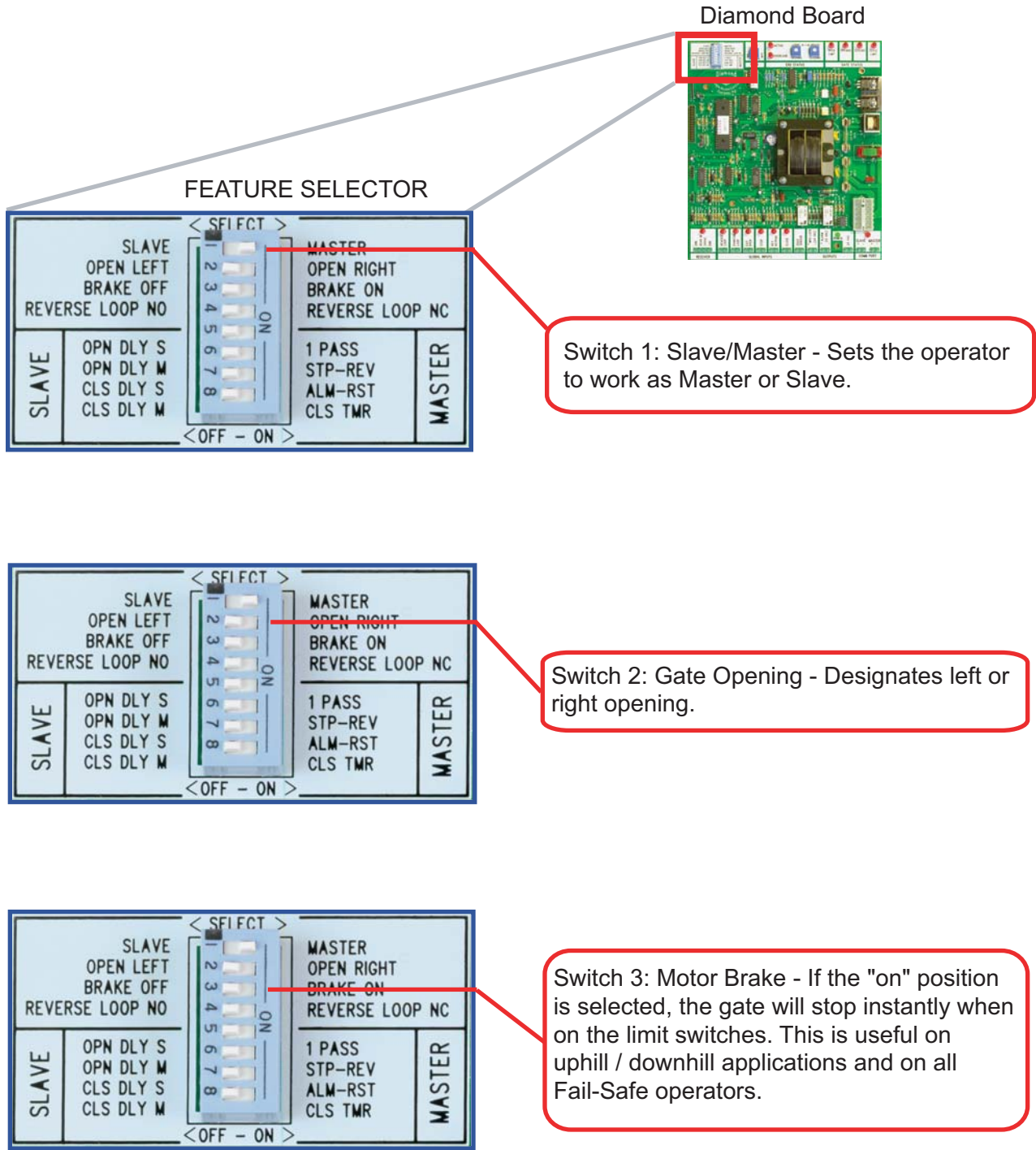

The Feature Selector

(Continued)

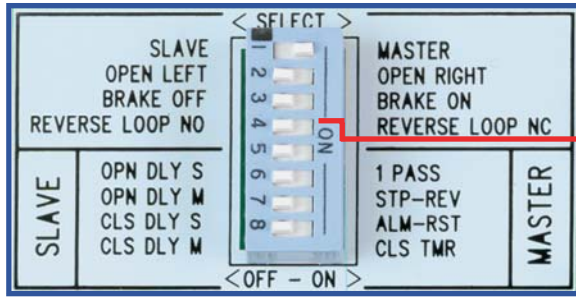

Switch 4: Reverse Loop - Sets the reverse loop to be normally open or to normally close. It is useful in Fail-Safe applications.

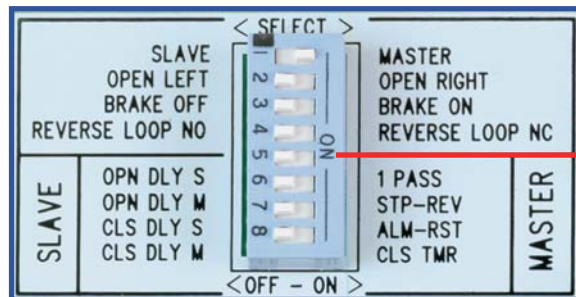

Switch 5: One Pass (On/Off) - This tailgating feature works with the reverse loop to allow only one car to pass. After the car passes, the gate closes instantly. If a second car approaches the gate stops. The operator resumes closing after the car leaves.

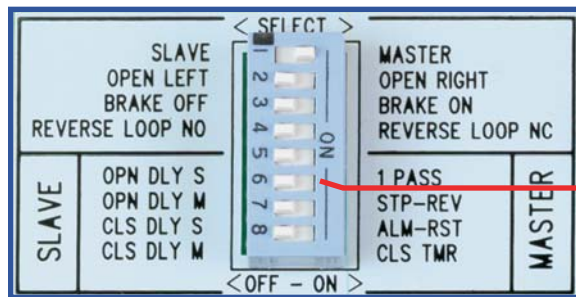

Switch 6: Stop-Reverse (On/Off) - This radio feature allows the transmitter to work as a three-button station and is useful for a partial opening. If selected, the first command will open the gate, the second will stop the gate, and the third will close the gate.

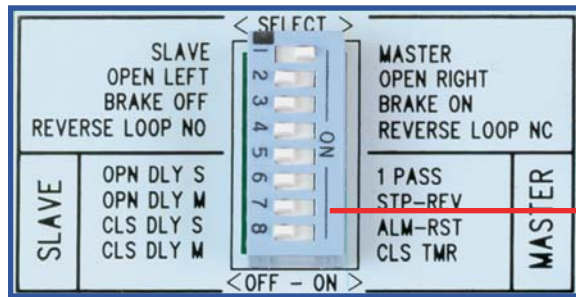

Switch 7: Alarm Reset (On/Off) - If the "on" position is selected, after the five minutes "shut down" time period the operator will reset and any input will be accepted. Normally, the power must be turned off to reset.

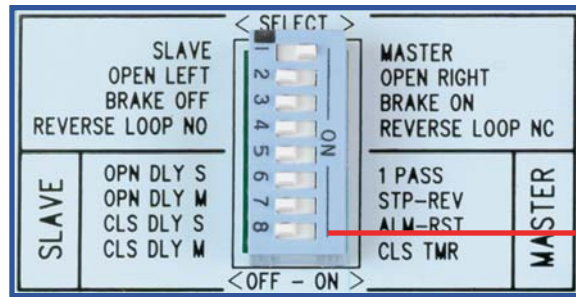

Switch 8: Close Timer (On/Off) - Sets the Close Timer to the "on" or "off" position.

Master and Slave Operation

Important: Be sure that the 120VAC power (for the Master and the Slave) are connected to the same circuit breaker.

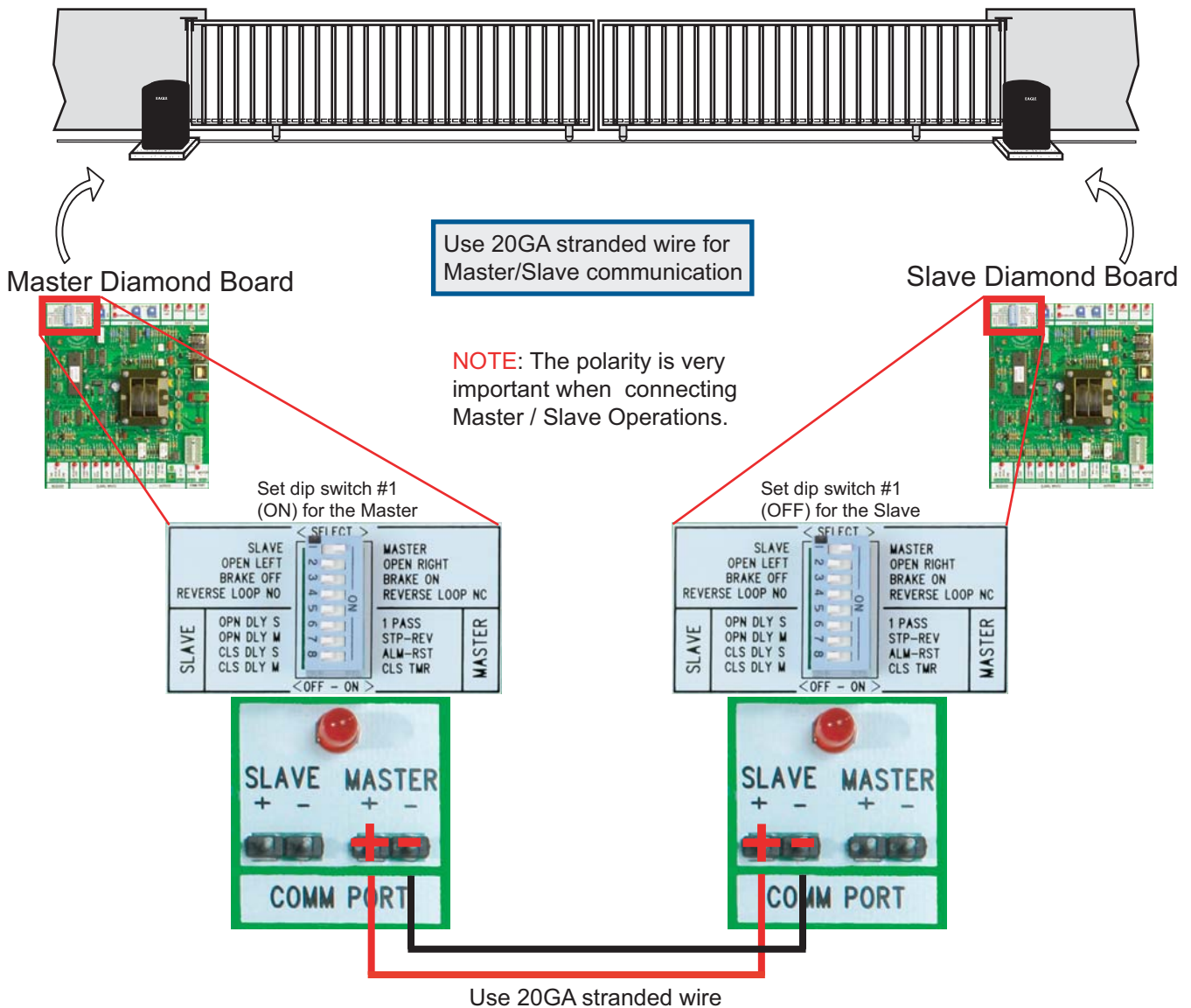

Master Control Options

Use the feature selector to choose available features by designating the various switches (1 through 8).

Gate opening direction, motor brake, reverse loop, one pass, stop reverse, alarm reset, and close timer.

Please refer to pages 10 & 11 for more information on individual switch functions.

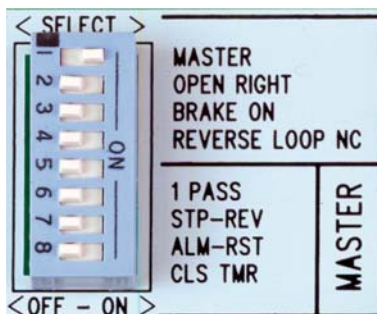

NOTE: Please remember the Eagle Diamond Control Board allows you to connect accessories to the Master or Slave operators.

These accessories include:
Reverse Loop, Phantom Loop, Exit Loop, 3 Button Station, Key Switch Lock Box, Fire Dept. Box, Edge Sensors, Telephone System...Etc.

Slave Control Options

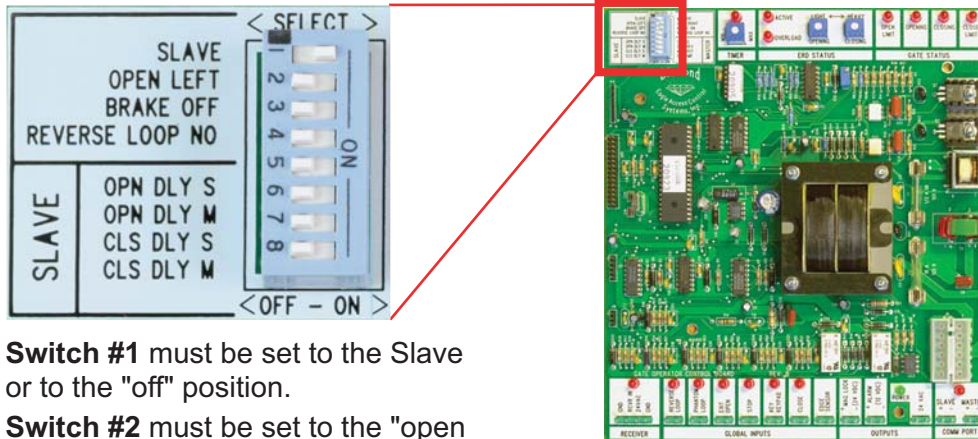

Switch #1 must be set to the Slave or to the "off" position.

Switch #2 must be set to the "open left" or to the "open right" position.

Switch #3 brake on / off.

Switch #4 Not in use.

Selecting The Delay Functions

The Eagle "Diamond" Control board was uniquely designed to allow the slave control to communicate to the master board all of the "Open-Delay" and "Close Delay" functions.

If no delay functions are needed, switches 5 through 8 must be in the off position.

Setting The Open Delay Function

Switches 5 & 6: Open Delay Slave (On/Off) - Selecting the switch to the "on" position delays the Slave (Sw. 5) or Master (Sw. 6) operator by 1 1/2 seconds on the open cycle. This is useful with magnetic lock applications.

Setting The Close Delay Function

Switches 7 & 8: Close Delay Master (On/Off) - Selecting the switch to the "on" position delays the Slave (Sw. 7) or Master (Sw. 8) operator by 1 - 6 seconds on the close cycle (adjustable by the Slave Timer shown below).

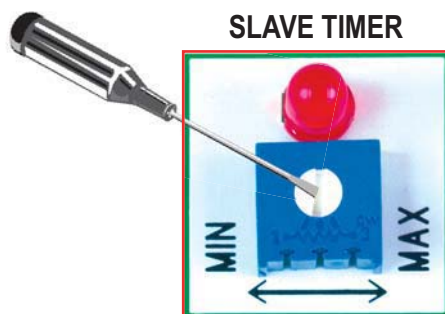
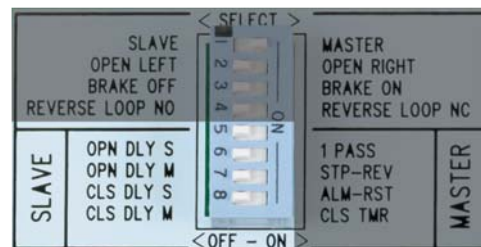

Diamond Control Board

Describing The Output Connections

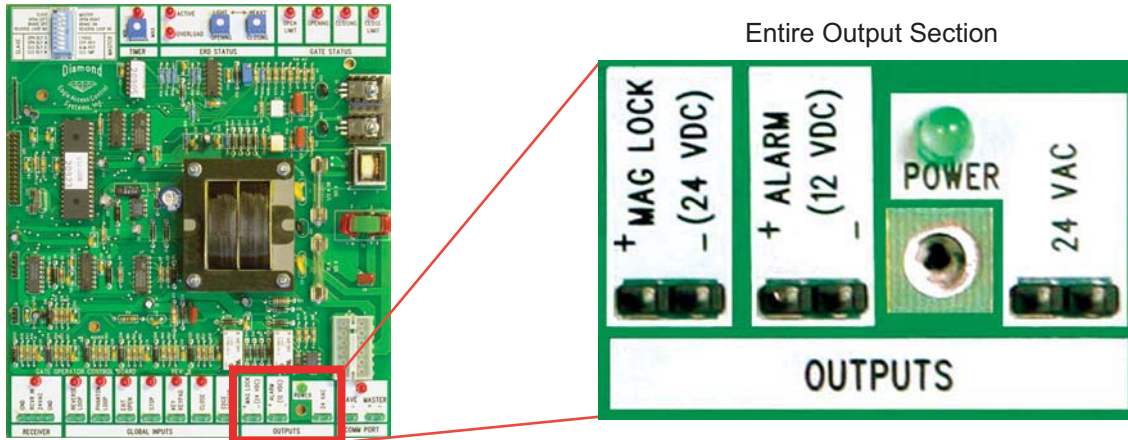

MAG Lock Solenoid Connections (24 VDC)

The Eagle Diamond Control Board provides a 24VDC and relay output for MAG Locks or Solenoids.

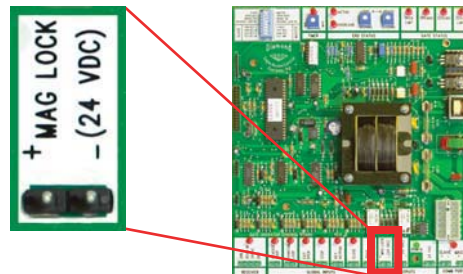

Alarm (12 VDC)

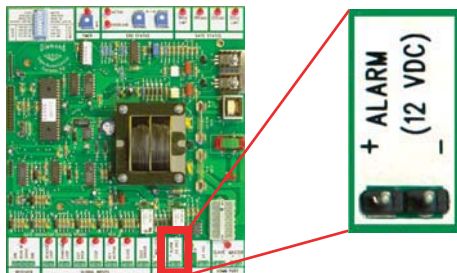

Safety Alarm: If the gate hits an obstruction twice while closing or opening, the system will shut down for 5 minutes. On the Diamond Board, you have two options of reset mode.



Selecting the "off" position will require a "manual reset" of the board if the previous happens. However, by selecting the "On" position, the system will automatically reset itself.

Power (24 VAC)

The Eagle Diamond Control Board provides 24 VAC Power, which can be used for loop detectors and receivers.

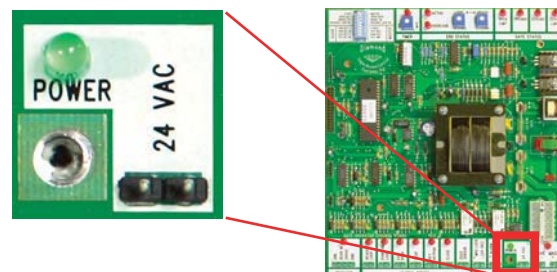

Connecting The Accessories

With the exception of the MAG Lock, all of these accessories can be installed on the Master or Slave operator.

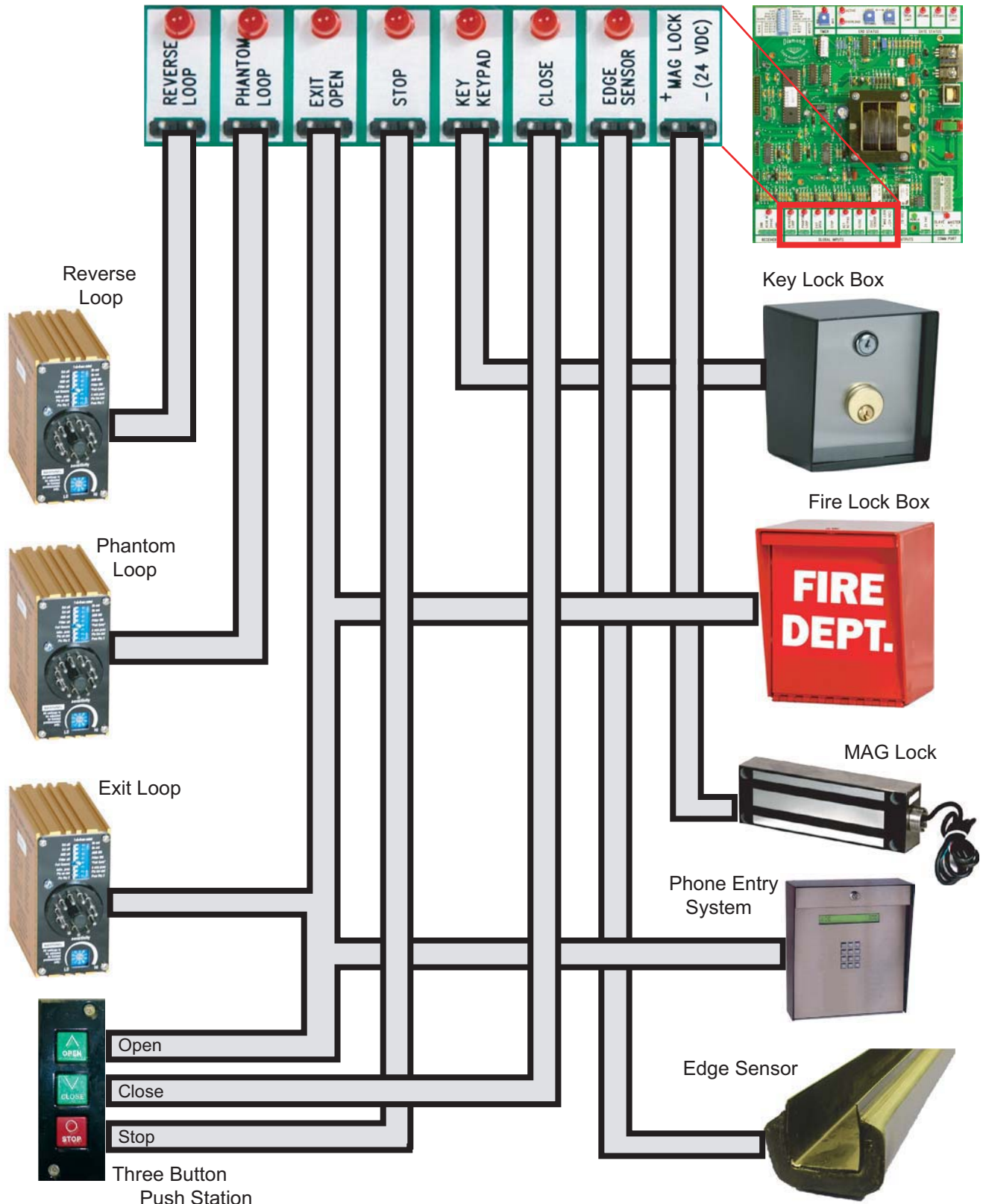

Description of Inputs

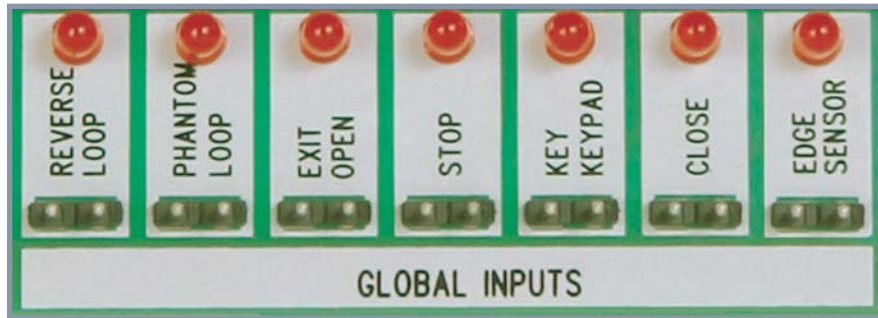

1.

Reverse Loop - Momentary or Continuous Signal

This input is active only when the gate is closing or when its fully open. If this input is active, the close timer is disabled. All vehicle detectors and photo-eyes should be connected here. Multiple devices may be connected in parallel.

2.

Phantom Loop - Momentary or Continuous Signal

This input is active only when the gate is at rest in the fully open position. The input has no effect on the gate when fully closed or while closing or opening. Continuous activation will prevent the gate from moving in the close direction. When the input is removed normal operation is resumed. This input is intended for a vehicle loop detector to sense a vehicle in the gate path. Multiple devices may be connected in parallel.

3.

Exit Open / Loop - Momentary or Continuous Input

Once activated the gate will fully open. Activation while the gate is closing will cause the gate to reopen. Continuous activation while the gate is open will disable the timer to close function from automatically closing the gate.

4.

Stop - Momentary or Continuous Signal

This function overrides all other signals. Once activated, the gate will immediately stop and await a new command. If the stop input is continuously activated, the gate will not move.

5.

Key / Keypad

Timer On - Momentary or Continuous Input

Once activated the gate will fully open. Activation while the gate is closing will cause the gate to reopen. Continuous activation while the gate is open will disable the timer to close function from automatically closing the gate.

5.

Key / Keypad (Continued)

Timer Off - Momentary Input

This function must be released and reentered to be recognized. This input is to be used for COMMAND OPEN / COMMAND CLOSE applications. The first signal will cause the gate to begin opening. The second signal will close the gate only when the gate is in the fully open position.

6.

Close - Momentary or Continuous Signal

Once activated the gate will fully close. Activation while the gate is opening has no effect.

7.

Edge Sensor - Momentary or Continuous Signal

This signal is active when the gate is opening and/or closing.

If activated when the gate is opening:

The gate will stop, pause and reverse in the close direction for 1 1/2 seconds and stop. Continuous activation will prevent the gate from moving in the opening direction. If the second activation occurs before the limit switch is activated, the gate will stop and reverse direction for 1 1/2 seconds and stop, thus activating the alarm mode. At this point the operator must be manually reset (ON/OFF) before normal operation can resume.

If activated when the gate is closing:

The gate will stop, pause and fully reopen. During this mode the timer to close, reverse loop, exit loop and phantom loop are disabled. The Key / Keypad and Receiver will cause the gate to close if a second activation occurs before the limit switch is activated. The gate will then stop and reverse direction for 1 1/2 seconds, stop again, thus activating the alarm mode. At this point the operator must be manually reset (ON/OFF) before normal operation can resume.

Multiple devices may be connected in parallel to the Edge Sensor Input.

Receiver Connections

The receiver terminal is mounted on the control box for easy installation and is pre-wired for a 3-wire or 4-wire receiver.

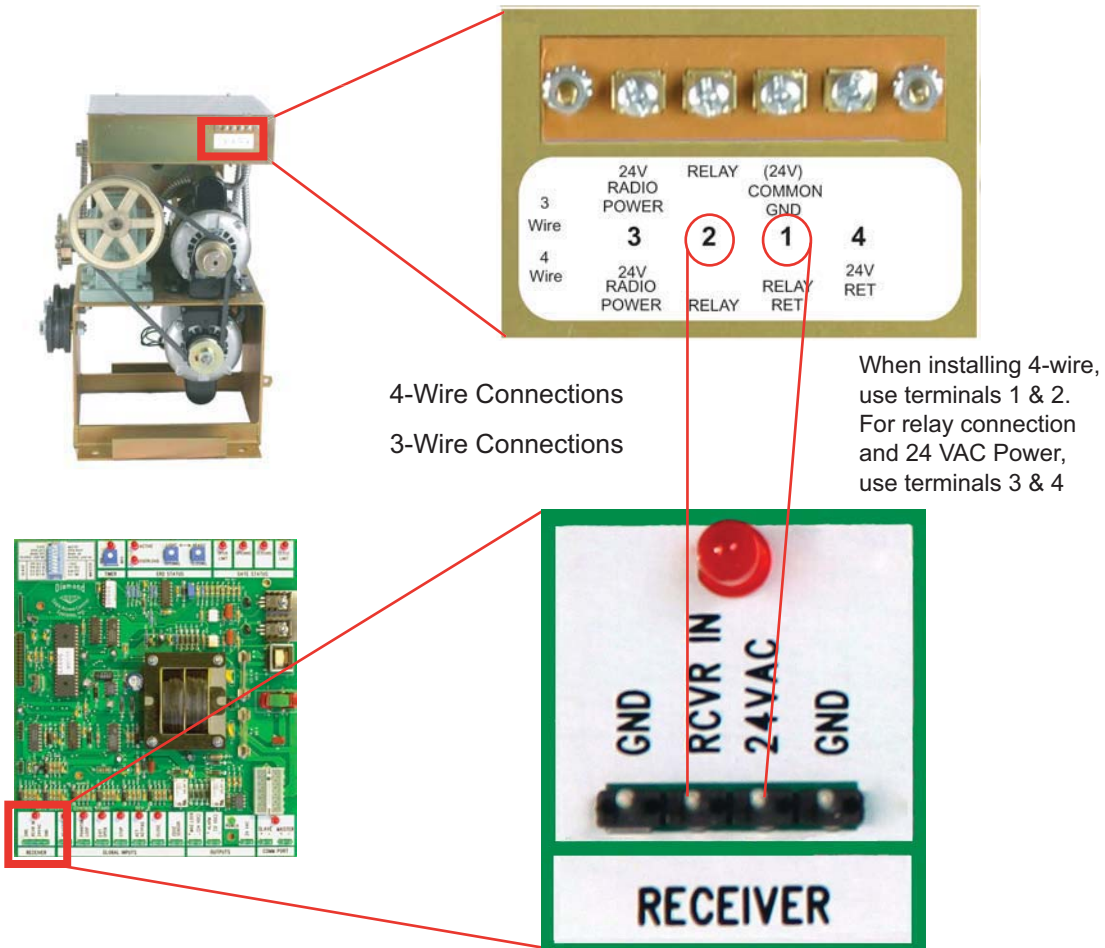

Gate Travel Distance / Setting The Limit Switches

The limit switches must be set so that the gate stops at the proper position. Follow these instructions to appropriately set the limit switches.

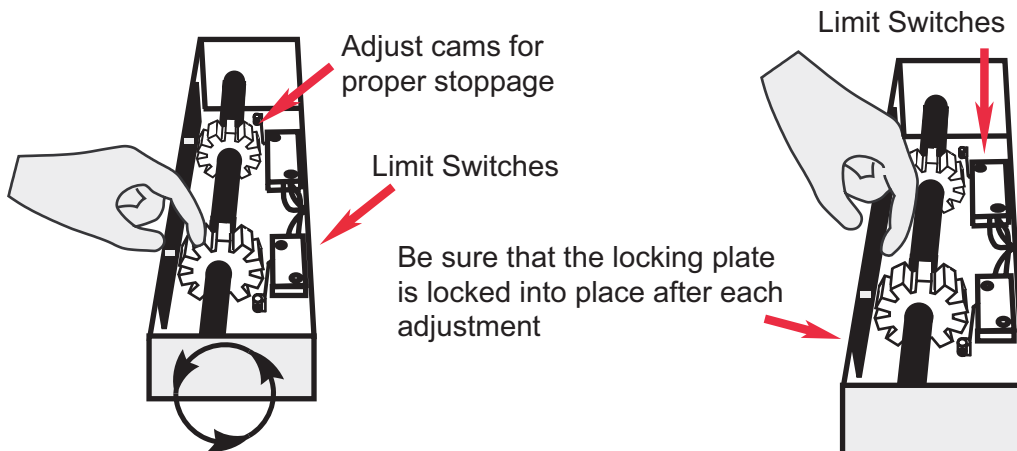

Emergency Releases

The Fail Secure System

Release Instructions:



- (1) Turn off the power - Failure to do so can result in serious injury or death.
- (2) Insert crank into the crank aperture
- (3) Turn the crank to open the gate

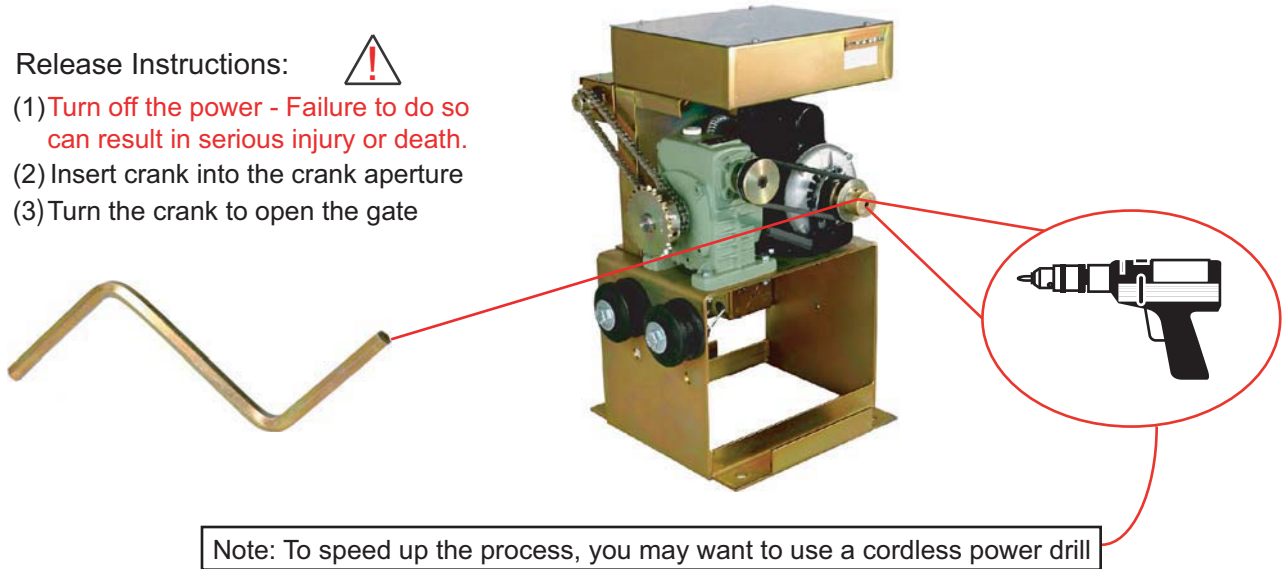

The Fail Safe System

The Fail Safe System **does not** require a crank or special tool to manually open the gate in case of emergency. If a situation does arise, simply **turn off the power switch** and push open the gate.

Optional Release Procedure

Using the Eagle-2070-Fire Box

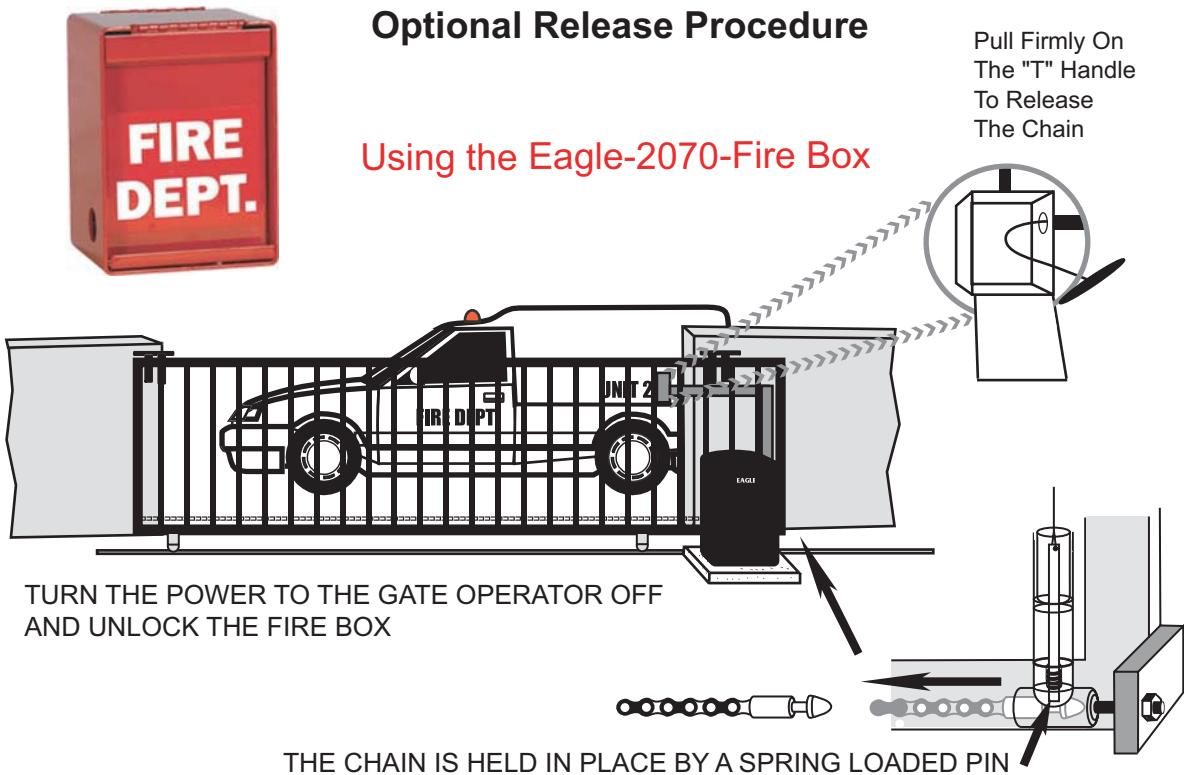

Mounting The Secondary Entrapment

Note: Eagle Access Control Systems, Inc. recommends the installation of Edge Sensors on all sliding gate operator systems.



All Contact Sensors
Are Connected To
Edge Sensor Inputs

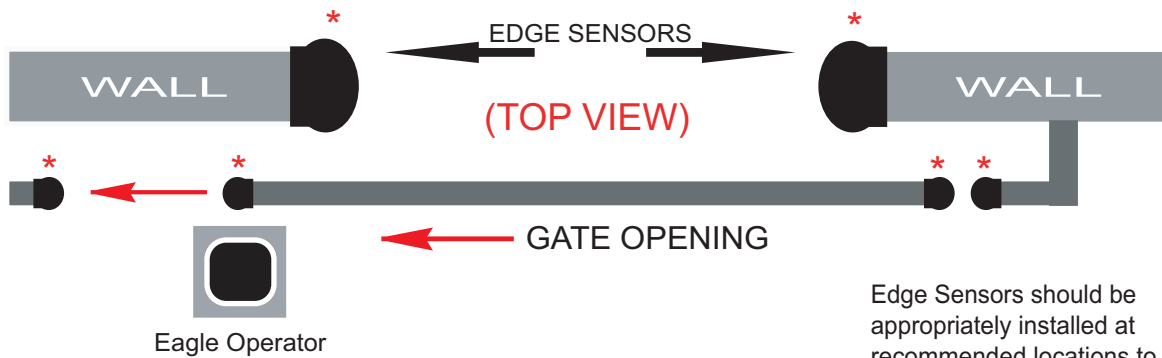
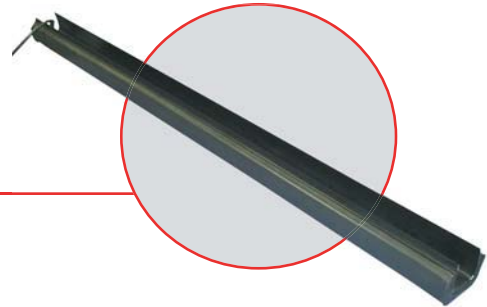

* All Edge Sensors are shown
at recommended locations.

Edge Sensors should be
appropriately installed at
recommended locations to
ensure proper entrapment
protection against injury.

Resetting The Motor

On all Eagle Access motors, a red reset button is available for resetting the motor.

If operator ceases to function:

**TURN THE POWER TO THE OPERATOR OFF
AND ALLOW FOR THE MOTOR TO COOL DOWN...**

then simply locate the reset button, press, and then turn the power back on.

EMERSON
MOTOR

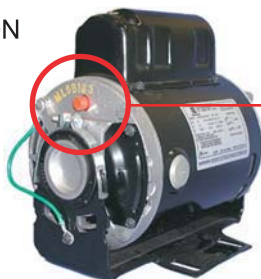

LEESON
MOTOR

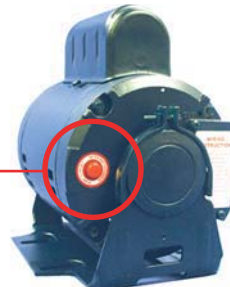

Control Board LED Indicators

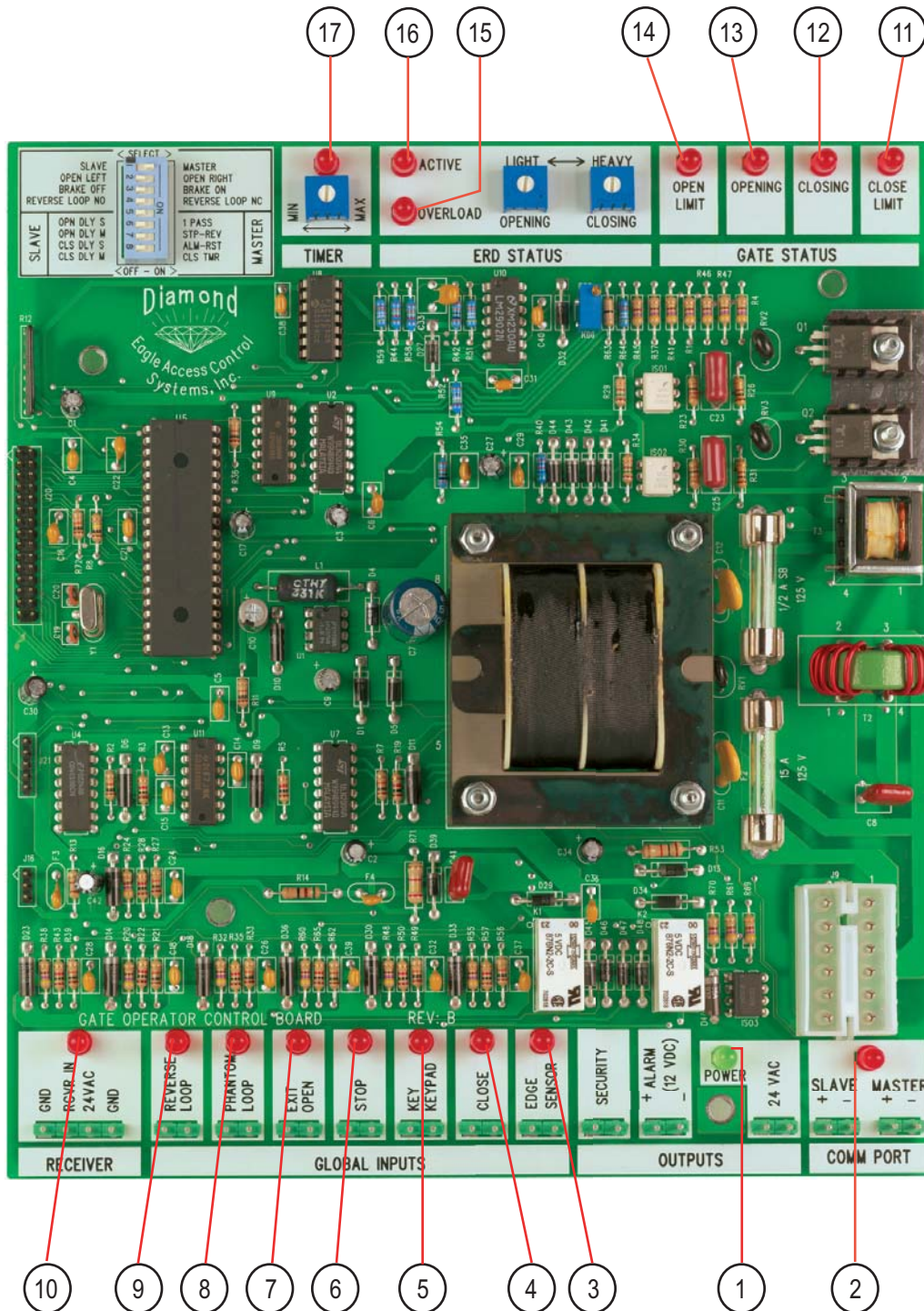

- | | | | |
|---------------------------------|-----------------|-----------------|--------------|
| 1. Power On | 5. Key / Keypad | 10. Receiver | 15. Overload |
| 2. Master / Slave Communication | 6. Stop | 11. Close Limit | 16. Active |
| 3. Edge Sensor | 7. Exit / Open | 12. Closing | 17. Timer |
| 4. Close | 8. Phantom Loop | 13. Opening | |
| | 9. Reverse Loop | 14. Open Limit | |

Troubleshooting

SYMPTOMS	PROBABLE CAUSES	REMEDY
Gate stops and reverses direction in mid travel and the OVERLOAD LED remains ON.	(A) Gate operator is not plumb and level. (B) ERD current sense may be set to sensitive. (C) Gate encountered an obstruction while in travel. (D) The Gate's V-Groove wheels are worn.	(A) Remount operator or chain brackets. (B) Turn the ERD sensor slightly in the clockwise direction. (C) Check and remove all obstructions. (D) Check and/or replace the V-Groove wheels.
Gate will not CLOSE.	(A) The Radio Receiver's LED remains on. (B) One or more of the global input LED(S) remain active. (C) Gate has reopened because it encountered an obstruction while closing. (D) The Loop Detector LED is on. (E) Switch #8 is not functioning.	(A) Remote or receiver has malfunctioned in the "on" position. (B) Check any Global Inputs for a possible short circuit. (C) Only key/keypad and receiver will resume normal operation. (D) Reset Loop Detector, verify correct wiring, set to a different frequency, and/or change the sensitivity of the Loop Detector. (E) Be sure that the "Close Timer" (switch #8) is set to the "on" position.
Gate will not OPEN.	(A) Motor overload. (B) Radio Receiver is not "on" when the remote control is activated. (C) The green LED is "off." (D) Fuse blown.	(A) Reset thermal breaker on motor. (See page 20) (B) The receiver in the gate operator has malfunctioned in the "off" position. (C) Turn "on" the power switch and/or reset the main circuit breaker. (D) Check and/or replace with a proper fuse.

COMMON OVERSIGHTS TO BE AWARE OF:

- (A) Switch #1 must be set to the "Master On" position, unless the operator is being used as a Slave unit.
- (B) Safety Loop Detectors must be connected to the Reverse Loop input. (See pages 16 & 17)
- (C) If the "Timer to Close" function is desired, switch #8 must be set to the "on" position.
- (D) It is Ok to call the Eagle Access Customer Service Department with any questions...we are here to serve YOU!

1-800-708-8848

Parts Breakdown / Eagle-2000

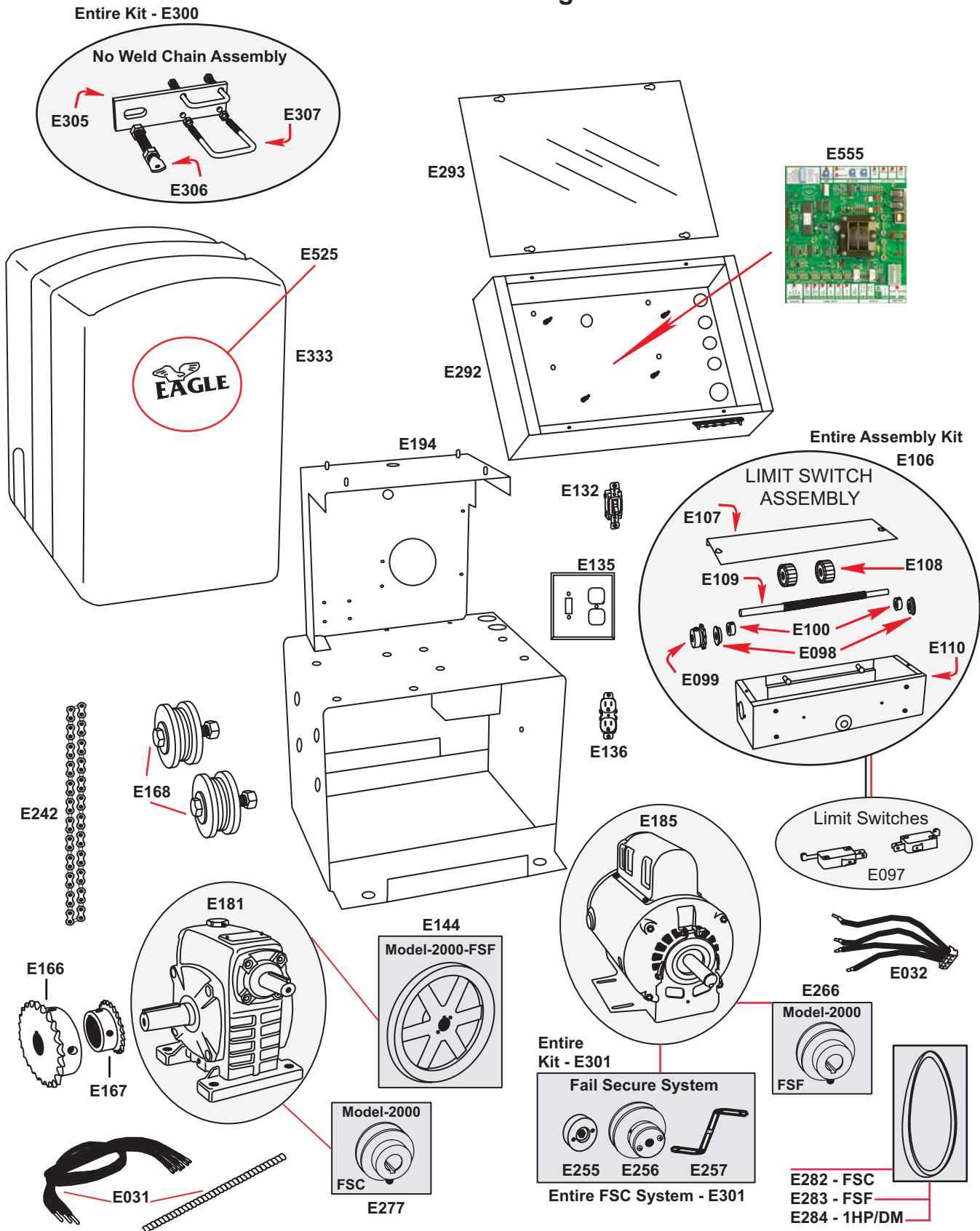

Parts Breakdown / Eagle-1000

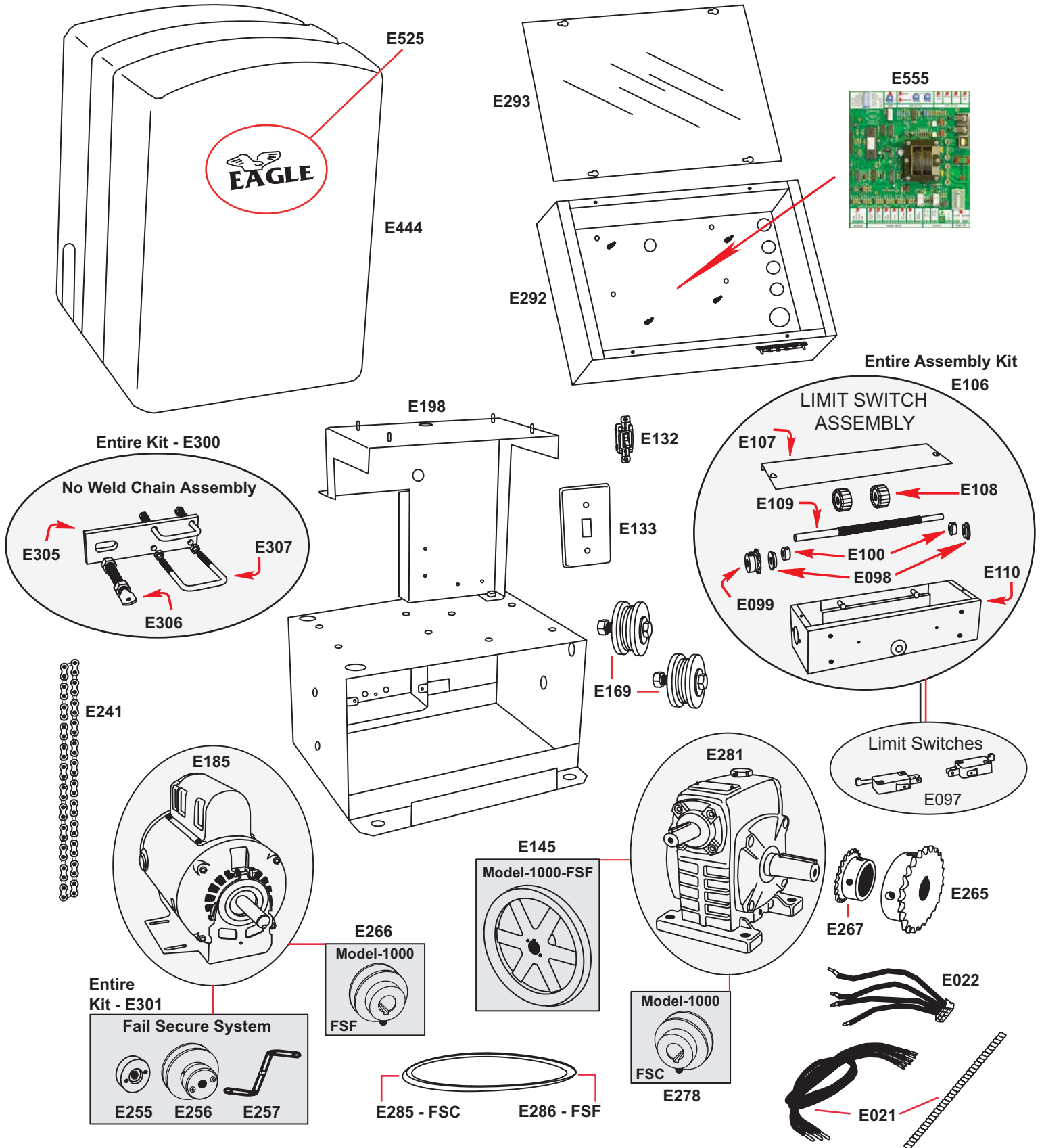

Operator Parts List

Eagle-2000 Slide Operator

- E333 - Operator Cover
- E293 - Plastic (Control Board Box) Cover
- E292 - Control Board Box
- E555 - Diamond Control Board
- E194 - Eagle-2000 Chassis
- E106 - Limit Switch (LS) Assembly (Complete)

- E-107 (LS) Box Cover Plate
- E-108 Adjustment Cams
- E-109 Threaded Shaft
- E-098 Shaft Bearings
- E-099 Shaft Sprocket
- E-100 Shaft Collar
- E-110 (LS) Box
- E-097 Limit Switches

- E185 - 1/2 HP Motor
- E266 - Fail-Safe Motor Pulley
- E301 - Fail-Secure (FSC) System (Complete)

- E255 - Motor Pulley
- E256 - Pulley w/ Release Outlet
- E257 - Release Crank

- E181 - Gear Reducer (GR)
- E144 - Fail-Safe (GR) Pulley
- E277 - Fail-Secure (GR) Pulley
- E167 - (GR) Limit Drive Sprocket
- E166 - (GR) Gate Drive Sprocket #41
- E366 - 2000-DM/1HP Gate Drive Sprocket #40
- E242 - Limit Chain
- E168 - Idler Pulley
- E282 - Fail-Secure V-Belt
- E283 - Fail-Safe V-Belt
- E284 - 1HP/DM V-Belt
- E132 - Electrical On/Off Switch
- E135 - Switch / Outlet Plate
- E136 - Electrical Outlet
- E031 - Motor Harness
- E032 - Receiver Harness
- E525 - Plastic Eagle Logo
- E300 - No Weld Chain Assembly (Complete)

- E305 - Chain Bracket
- E306 - Chain Bolt w/ Nuts
- E307 - U-Bolts

Eagle-1000 Slide Operator

- E444 - Operator Cover
- E293 - Plastic (Control Board Box) Cover
- E292 - Control Board Box
- E555 - Diamond Control Board
- E198 - Eagle-1000 Chassis
- E106 - Limit Switch (LS) Assembly (Complete)

- E-107 (LS) Box Cover Plate
- E-108 Adjustment Cams
- E-109 Threaded Shaft
- E-098 Shaft Bearings
- E-099 Shaft Sprocket
- E-100 Shaft Collar
- E-110 (LS) Box
- E-097 Limit Switches

- E185 - 1/2 HP Motor
- E266 - Fail-Safe Motor Pulley
- E301 - Fail-Secure (FSC) System (Complete)

- E255 - Motor Pulley
- E256 - Pulley w/ Release Outlet
- E257 - Release Crank

- E281 - Gear Reducer (GR)
- E145 - Fail-Safe (GR) Pulley
- E278 - Fail-Secure (GR) Pulley
- E267 - (GR) Limit Drive Sprocket
- E265 - (GR) Gate Drive Sprocket
- E241 - Limit Chain
- E169 - Idler Pulley
- E285 - Fail-Secure V-Belt
- E286 - Fail-Safe V-Belt
- E132 - Electrical On/Off Switch
- E133 - Switch / Outlet Plate
- E021 - Motor Harness
- E022 - Receiver Harness
- E525 - Plastic Eagle Logo
- E300 - No Weld Chain Assembly (Complete)

- E305 - Chain Bracket
- E306 - Chain Bolt w/ Nuts
- E307 - U-Bolts

If you are uncertain of a specific part you need,
please call us at the number below for assistance.

Eagle Access Control Systems, Inc.

Eagle Access Control Systems, Inc. designs its gate operators with the dealer/installer in mind, constructing all Eagle operators to be easy to install and to service. From our very first operator, the Eagle-2000, with its superb features and easy to install construction, to the full range of commercial and residential sliding and swing gate operators we now offer, Eagle Access has always provided what our customers need. As our number of distributors grows, we are committed now more than ever to full and effective customer service. If you have any questions or concerns regarding any of our products, please do not hesitate to contact us.

Toll Free (800)708-8848

Phone (818)764-6690

Fax (818)764-6869

Address:

13133 Saticoy St.

North Hollywood, CA 91605

www.eagleoperators.com

